

FLUKE®

Hart Scientific®

1522
*Handheld Thermometer Readout
User's Guide*

Limited Warranty & Limitation of Liability

Each product from Fluke Corporation, Hart Scientific Division ("Hart") is warranted to be free from defects in material and workmanship under normal use and service. The warranty period is 1 year for the Handheld Thermometer Readout. The warranty period begins on the date of the shipment. Parts, product repairs, and services are warranted for 90 days. The warranty extends only to the original buyer or end-user customer of a Hart authorized reseller, and does not apply to fuses, disposable batteries or to any other product, which in Hart's opinion, has been misused, altered, neglected, or damaged by accident or abnormal conditions of operation or handling. Hart warrants that software will operate substantially in accordance with its functional specifications for 90 days and that it has been properly recorded on non-defective media. Hart does not warrant that software will be error free or operate without interruption. Hart does not warrant calibrations on the Handheld Thermometer Readout.

Hart authorized resellers shall extend this warranty on new and unused products to end-user customers only but have no authority to extend a greater or different warranty on behalf of Hart. Warranty support is available if product is purchased through a Hart authorized sales outlet or Buyer has paid the applicable international price. Hart reserves the right to invoice Buyer for importation costs of repairs/replacement parts when product purchased in one country is submitted for repair in another country.

Hart's warranty obligation is limited, at Hart's option, to refund of the purchase price, free of charge repair, or replacement of a defective product which is returned to a Hart authorized service center within the warranty period.

To obtain warranty service, contact your nearest Hart authorized service center or send the product, with a description of the difficulty, postage, and insurance prepaid (FOB Destination), to the nearest Hart authorized service center. Hart assumes no risk for damage in transit. Following warranty repair, the product will be returned to Buyer, transportation prepaid (FOB Destination). If Hart determines that the failure was caused by misuse, alteration, accident or abnormal condition or operation or handling, Hart will provide an estimate or repair costs and obtain authorization before commencing the work. Following repair, the product will be returned to the Buyer transportation prepaid and the Buyer will be billed for the repair and return transportation charges (FOB Shipping Point).

THIS WARRANTY IS BUYER'S SOLE AND EXCLUSIVE REMEDY AND IS IN LIEU OF ALL OTHER WARRANTIES, EXPRESS OR IMPLIED, INCLUDING BUT NOT LIMITED TO ANY IMPLIED WARRANTY OF MERCHANTABILITY OR FITNESS FOR A PARTICULAR PURPOSE. HART SHALL NOT BE LIABLE FOR ANY SPECIAL, INDIRECT, INCIDENTAL, OR CONSEQUENTIAL DAMAGES OR LOSSES, INCLUDING LOSS OF DATA, WHETHER ARISING FROM BREACH OF WARRANTY OR BASED ON CONTRACT, TORT, RELIANCE OR ANY OTHER THEORY.

Since some countries or states do not allow limitation of the term of an implied warranty, or exclusion or limitation of incidental or consequential damages, the limitations and exclusions of this warranty may not apply to every buyer. If any provision of this Warranty is held invalid or unenforceable by a court of competent jurisdiction, such holding will not affect the validity or enforceability of any other provision.

Fluke Corporation, Hart Scientific Division

799 E. Utah Valley Drive • American Fork, UT 84003-9775 • USA
Phone: +1.801.763.1600 • Telefax: +1.801.763.1010
E-mail: support@hartscientific.com

www.hartscientific.com

Subject to change without notice. • Copyright © 2005 • Printed in USA

Table of Contents

1	Before You Start	1
1.1	Symbols Used	1
1.2	Safety Information	2
1.2.1	WARNINGS	2
1.2.2	CAUTIONS	3
1.3	Authorized Service Centers.	4
2	Introduction	7
3	Specifications and Environmental Conditions	9
3.1	Specifications	9
3.2	Environmental Conditions.	10
4	Quick Start	11
4.1	Unpacking	11
4.2	Use Proper Care with the 1522 and Accessories	11
4.3	Learn About the Features and Components	11
4.4	Connect the Probe	12
4.5	Connect the Power Source	12
4.6	Switch the Power On	12
4.7	Measure Temperature	12
5	Parts and Controls	15
5.1	Front View.	15
5.2	Top and Side View	17
5.3	Back View	18
5.4	Internal Features.	18
5.5	Accessories	19
6	General Operation	21
6.1	Battery.	21
6.2	DC Power Source	22
6.3	Power Button	23
6.4	Display and Backlight.	23
6.5	Probe	24

6.6	INFO-CON Connector	25
7	Display Functions.	27
7.1	Blank Mode	28
7.2	Min/Max Mode	29
7.3	Demand Logging	29
7.3.1	Demand Log Label and Data Storage	29
7.3.2	Dump Data?	30
7.3.3	Clear Log?	30
7.4	Auto Logging	30
7.4.1	Clear Autolog?	31
7.4.2	Log Rate.	31
7.4.3	Autolog Label.	31
7.4.4	Autologged Data Storage	31
7.4.5	Dump Data?	32
7.5	Delta(x) Mode.	32
7.6	Units.	32
7.7	Rate	33
7.8	Resolution	33
7.9	CAL MODE.	33
7.9.1	Mtr Due	35
7.9.2	Prb Due	35
7.9.3	Time.	35
7.9.4	Passcode.	35
7.9.5	Date	36
7.9.6	Probe Lock	36
7.9.7	Prb #.	36
7.9.8	Prb Type.	36
7.9.9	ITS-90.	37
7.9.10	IEC751	39
7.9.11	CVD.	39
7.9.12	YSI-400	39
7.9.13	THERM	40
7.9.14	Probe Wires	40
7.9.15	PCal	41
7.9.16	PDue.	41
7.9.17	Digital Filter.	41
7.9.18	MCal	41
7.9.19	MDue	42
7.9.20	CAL1 and CAL2	42
8	Communications Interface.	43
8.1	RS-232 Connection	43
8.2	Communication Command List.	44
8.2.1	Primary Commands	44

8.2.2	Calibration Commands	46
9	Calibration	49
9.1	Required Equipment.	49
9.2	Calibration Procedure	49
10	Maintenance	51
11	Troubleshooting.	53
11.1	An Error Message Is Displayed	53
11.2	Downloading Autologged Data	54
11.3	CE Comments	55
11.3.1	EMC Directive	55
11.3.1.1	Immunity Testing	56
11.3.1.2	Emission Testing	56
11.3.2	Low Voltage Directive (Safety)	56

Figures and Tables













- Table 1 International Electrical Symbols 1
- Figure 1 Front View 15
- Figure 2 Top and Side View 17
- Figure 3 INFO-CON Connector 19
- Figure 4 Battery Installation 21
- Figure 5 12V DC Power Source Polarity 23
- Figure 6 Probe Wiring Diagrams 26
- Figure 7 Operating Modes Flowchart 28
- Figure 8 RS-232 Wiring 43



1 Before You Start

1.1 Symbols Used

Table 1 lists the International Electrical Symbols. Some or all of these symbols may be used on the instrument or in this manual.

Table 1 International Electrical Symbols

Symbol	Description
	AC (Alternating Current)
	AC-DC
	Battery
	CE Complies with European Union Directives
	DC
	Double Insulated
	Electric Shock
	Fuse
	PE Ground
	Hot Surface (Burn Hazard)
	Read the User's Manual (Important Information)
	Off
	On

Symbol	Description
	Canadian Standards Association
CAT II	OVERVOLTAGE (Installation) CATEGORY II, Pollution Degree 2 per IEC1010-1 refers to the level of Impulse Withstand Voltage protection provided. Equipment of OVERVOLTAGE CATEGORY II is energy-consuming equipment to be supplied from the fixed installation. Examples include household, office, and laboratory appliances.
	C-TIC Australian EMC Mark
	The European Waste Electrical and Electronic Equipment (WEEE) Directive (2002/96/EC) mark.

1.2 Safety Information

Use this instrument only as specified in this manual. Otherwise, the protection provided by the instrument may be impaired.

The following definitions apply to the terms “Warning” and “Caution”.

- “WARNING” identifies conditions and actions that may pose hazards to the user.
- “CAUTION” identifies conditions and actions that may damage the instrument being used.

1.2.1 WARNINGS

To avoid personal injury, follow these guidelines.

- **DO NOT** use this unit in environments other than those listed in the User's Guide.
- Follow all safety guidelines listed in the User's Guide.
- Calibration equipment should only be used by trained personnel.
- If this equipment is used in a manner not specified by the manufacturer, the protection provided by the equipment may be impaired.
- Before initial use, or after transport, or after storage in humid or semi-humid environments, or anytime the instrument has not been energized for more than 10 days, the instrument needs to be energized for a “dry-out” period of 2 hours before it can be assumed to meet all of the safety requirements of the IEC 1010-1. If the product is wet or has been in a wet environment, take necessary measures to remove moisture prior to applying power such as storage in a low humidity temperature chamber operating at 50°C for 4 hours or more.
- This instrument can measure extreme temperatures. Precautions must be taken to prevent personal injury or damage to objects. Probes may be extremely hot or cold. Cautiously handle probes to prevent personal injury.

Carefully place probes on a heat/cold resistant surface or rack until they reach room temperature.

- The AC adapter can present safety concerns if misused or damaged. To avoid the risk of electric shock or fire, do not use the AC adapter outdoors or in a dusty, dirty, or wet environment. If the cord, case, or plug of the adapter is damaged in any way, discontinue its use immediately and have it replaced. Never disassemble the AC adapter. Use only the AC adapter provided with the instrument or equivalent adapter recommended by the manufacturer of this instrument.
- The AC adapter has circuits with high voltage inside that could present danger of electrical shock or fire if exposed. If the AC adapter is damaged in any way or becomes hot, discontinue its use immediately, disconnect it from any AC supply, and have it replaced. Do not attempt to open, repair, or continue using a damaged or defective AC adapter.
- The instrument batteries can present danger if not handled properly. To avoid the risk of exposure to dangerous substances or explosion, immediately remove the batteries and discontinue use if they leak or become damaged. Never allow the batteries to be shorted, heated, punctured, or dropped. If the instrument is physically damaged, immediately remove the batteries to insure that they do not become shorted. While removed from the instrument, store the batteries in a location so that they do not come into contact with metal or fluids that might short circuit the batteries and where they are safe from excessive temperatures. Used batteries must be disposed of properly. Check your local regulations for additional information. Never dispose of batteries in fire which may result in explosion with the possibility of personal injury or property damage.
- **DO NOT** use this instrument in combination with any probe (RTD or thermistor) to measure the temperature or resistance of any device that is electrically energized. Severe electric shock, personal injury, or death may occur.

1.2.2

CAUTIONS

To avoid possible damage to the instrument, follow these guidelines.

- If the instrument is dropped, struck, or handled in a way that causes internal or external physical damage, immediately unplug the AC adapter, remove the batteries, discontinue use, and contact the factory for repair. Do not attempt to disassemble or repair the instrument, batteries, or AC adapter. Refer repairs or replacement components to the manufacturer.
- The instrument and thermometer probes are sensitive and can be easily damaged. Always handle these devices with care. **DO NOT** allow them to be dropped, struck, stressed, or overheated.
- **DO NOT** leave the AC adapter plugged in for more than 24 consecutive hours or the battery life could be degraded.
- Probes are fragile devices which can be damaged by mechanical shock, overheating, and absorption of moisture or fluids in the wires or hub.

Damage may not be visibly apparent but nevertheless can cause drift, instability, and loss of accuracy. Observe the following precautions:

- **DO NOT** allow probes to be dropped, struck, bent, or stressed.
- **DO NOT** overheat probes beyond their recommended temperature range.
- **DO NOT** allow any part of the probe other than the sheath to be immersed in fluid.
- **DO NOT** allow the probe hub or wires to be exposed to excessive temperatures.
- Keep the probe wires clean and away from fluids.

1.3 Authorized Service Centers

Please contact one of the following authorized Service Centers to coordinate service on your Hart product:

Fluke Corporation, Hart Scientific Division

799 E. Utah Valley Drive
American Fork, UT 84003-9775
USA

Phone: +1.801.763.1600
Telefax: +1.801.763.1010
E-mail: support@hartscientific.com

Fluke Nederland B.V.

Customer Support Services
Science Park Eindhoven 5108
5692 EC Son
NETHERLANDS

Phone: +31-402-675300
Telefax: +31-402-675321
E-mail: ServiceDesk@fluke.nl

Fluke Int'l Corporation

Service Center - Instrimpex
Room 2301 Sciteck Tower
22 Jianguomenwai Dajie
Chao Yang District

Beijing 100004, PRC
CHINA

Phone: +86-10-6-512-3436
Telefax: +86-10-6-512-3437
E-mail: xingye.han@fluke.com.cn

Fluke South East Asia Pte Ltd.

Fluke ASEAN Regional Office
Service Center
60 Alexandra Terrace #03-16
The Comtech (Lobby D)
118502
SINGAPORE

Phone: +65 6799-5588
Telefax: +65 6799-5588
E-mail: antng@singa.fluke.com

When contacting these Service Centers for support, please have the following information available:

- Model Number
- Serial Number
- Voltage
- Complete description of the problem

2 Introduction

The Hart 1522 is a low-cost, high-accuracy digital thermometer readout designed to be used with PRTs and thermistors. The unique combination of features makes this instrument suitable for a wide variety of applications in industry. Features and capabilities of the 1522 include the following:

- Accepts input from platinum resistance thermometers (PRTs) and thermistors
- Works with Hart's INFO-CON probe connector (which is partially based on U.S. Patent 5,857,777) to automatically recognize the type of sensor and its characteristics
- Alerts the operator automatically when the probe calibration or meter calibration expires
- Measures with an accuracy of $\pm 0.025^{\circ}\text{C}$ at 25°C with PRTs and $\pm 0.005^{\circ}\text{C}$ at 25°C with thermistors
- Accepts three- or four-wire sensors to eliminate lead resistance errors
- Measures with a fast one-second measurement cycle
- Displays maximum, minimum, and delta temperatures
- Uses a unique factory-assigned passcode to protect programmed settings
- Displays measurements and settings on a high-contrast LCD display
- Communicates with other equipment or a computer using an RS-232 serial interface
- Can be powered from its AC adapter or rechargeable battery
- Stores up to 10,000 readings with reading, units, date, time, and label in autologging mode at user selected intervals
- Stores up to 100 readings with reading, units, date, time, and label in demand logging mode
- Stores 25 labels (8 characters) for easy recognition of logged data
- Stops logging once maximum readings are stored. Memory must be cleared to store additional data
- Starts and stops logging both from the front panel and through the RS-232 interface
- Allows user to select a label for every reading stored in demand logging mode

3 Specifications and Environmental Conditions

3.1 Specifications

Resistance Range	0 Ω to 500 k Ω
Resistance Accuracy, PRT, one year†	0 Ω to 25 Ω : 0.002 Ω 25 Ω to 400 Ω : 0.008% (80 ppm) of reading
Resistance Accuracy, thermistor, one year†	0 Ω to 2 k Ω : 0.4 Ω 2 k Ω to 200 k Ω : 0.02% (200 ppm) of reading 200 k Ω to 500 k Ω : 0.03% (300 ppm) of reading
Temperature Range	PRT: -200°C to 962°C (-328°F to 1764°F) Thermistor: -50°C to 150°C (-58°F to 302°F)
Temperature Accuracy, PRT†	-200°C to 100°C: $\pm 0.025^\circ\text{C}$ ($\pm 0.045^\circ\text{F}$) 100°C to 400°C: $0 \pm 0.05^\circ\text{C}$ ($\pm 0.09^\circ\text{F}$) 400°C to 800°C: $\pm 0.1^\circ\text{C}$ ($\pm 0.18^\circ\text{F}$) 800°C to 962°C: $\pm 0.15^\circ\text{C}$ ($\pm 0.27^\circ\text{F}$)
Temperature Accuracy, 2.25 k Ω thermistor†	-50 to 25°C: $\pm 0.005^\circ\text{C}$ ($\pm 0.009^\circ\text{F}$) 25°C to 50°C: $\pm 0.01^\circ\text{C}$ ($\pm 0.018^\circ\text{F}$) 50°C to 75°C: $\pm 0.03^\circ\text{C}$ ($\pm 0.054^\circ\text{F}$) 75°C to 100°C: $\pm 0.08^\circ\text{C}$ ($\pm 0.144^\circ\text{F}$)
Temperature Accuracy, 10 k Ω thermistor†	0 to 50°C: $\pm 0.005^\circ\text{C}$ ($\pm 0.009^\circ\text{F}$) 50°C to 75°C: $\pm 0.01^\circ\text{C}$ ($\pm 0.018^\circ\text{F}$) 75°C to 100°C: $\pm 0.02^\circ\text{C}$ ($\pm 0.036^\circ\text{F}$) 100°C to 125°C: $\pm 0.05^\circ\text{C}$ ($\pm 0.09^\circ\text{F}$) 125°C to 150°C: $\pm 0.1^\circ\text{C}$ ($\pm 0.18^\circ\text{F}$)
Temperature Accuracy, 100 k Ω thermistor†	0 to 50°C: 0.006°C (0.011°F) 50°C to 150°C: 0.009°C (0.016°F)
Resistance Resolution	0.001 Ω
Temperature Resolution	0.001°C, F, K, R
Probe	IEC-751 or DIN-43760 PRT Callendar-Van Dusen calibrated PRT; nominal 100 Ω ITS-90 calibrated 25 Ω or 100 Ω PRT YSI-400 series or equivalent 2252 Ω thermistor Steinhart-Hart thermistor polynomial; nominal R(25°C) 2k Ω to 100k Ω
Probe Connector	Hart INFO-CON connector
Maximum Acceptable Probe Lead Resistance	10 Ω
Probe Excitation Current	PRT: 0.5 mA Thermistor: 5 μA
Measurement Period	1 second

Digital Filter	Exponential with adjustable time constant (1 to 60 seconds)
Remote Communications	RS-232 serial
Display	LCD, 6-digit x 7-segment with 16-character alphanumeric
Operating Temperature Range	0 to 40°C (32 to 104°F) absolute 15 to 35°C (59 to 95°F) full accuracy
Power	12 VDC (AC adapter included) Rechargeable NIMH batteries (included)
Safety	OVERVOLTAGE (Installation) CATEGORY II, Pollution Degree 2 per IEC1010-1 refers to the level of Impulse Withstand Voltage protection provided. Equipment of OVERVOLTAGE CATEGORY II is energy-consuming equipment to be supplied from the fixed installation. Examples include household, office, and laboratory appliances.
Size	7.75"H x 4.2"W x 1.5"D (20 cm H x 11 cm W x 4 cm D)
Weight	0.4 kg (1.0 lb.)

†Accuracy specifications apply from 15 to 35°C. Accuracy specifications over the entire absolute operating range are 1.5 times the stated values. Temperature accuracy does not include probe uncertainty or probe characterization errors. The practical measurement range may be limited by the sensor.

3.2 Environmental Conditions

Although the instrument has been designed for optimum durability and trouble-free operation, it must be handled with care. The instrument should not be operated in an excessively dusty, dirty, or wet environment. Maintenance and cleaning recommendations can be found in the Maintenance section of this manual.

For full accuracy, operate the instrument in ambient temperatures between 15-35°C (59-95°F). Do not operate the instrument in an environment colder than 5°C (41°F) or warmer than 50°C (122°F).

The instrument operates safely under the following conditions:

- Operating temperature range: absolute 5–50°C (41–122°F); full accuracy 15-35°C (59-95°F)
- ambient relative humidity: maximum 80% for temperature <31°C, decreasing linearly to 50% at 40°C
- Pressure: 75kPa-106kPa
- Vibration should be minimized
- Altitude less than 2,000 meters
- Indoor use only

4 Quick Start

This section briefly explains the basics of setting up and operating your thermometer readout.

4.1 Unpacking

Carefully unpack the 1522 and accessories and inspect them to make sure all components are present and in satisfactory condition. Verify that the following items are present:

- 1522 Thermometer Readout
- AC Adapter (clamp-on ferrite installed)
- Serial Cable
- User's Guide
- Report of Calibration
- Calibration Label
- Passcode Notice
- INFO-CON Connector
- Clamp-on ferrite with installation instructions for probe
- Probe (optional—must be purchased separately)

If all items are not present, contact an Authorized Service Center (see Section 1.3).

4.2 Use Proper Care with the 1522 and Accessories

First and most important is to understand the safety issues related to the 1522 and its accessories. Be aware that potential hazards exist due to high temperatures, high voltages, and battery chemicals. Carefully read Section .



CAUTION: *The 1522 and any thermometer probes are sensitive instruments that can be easily damaged. Always handle these devices with care. DO NOT allow them to be dropped, struck, stressed, or overheated.*

4.3 Learn About the Features and Components

Familiarize yourself with the features and accessories of the 1522 by reading Section 5.

4.4 Connect the Probe

The PRT or thermistor probe connects to the top of the 1522 using Hart's unique INFO-CON probe connector. The probe connector is inserted into the top of the instrument with the ridged to the back and fits snugly and locked into place when it is fully inserted.

The INFO-CON probe connector includes a memory device that **stores the unique characteristics of the probe**, allowing the 1522 to measure temperature accurately. If your probe was purchased from Hart for use with the 1522, it should already have the connector attached and properly programmed. You can use your own probe with the 1522, but you must attach it to an INFO-CON connector. See Section 6.6 for more information on the INFO-CON connector and instructions on properly attaching the probe to the connector.

4.5 Connect the Power Source

The 1522 draws power either from a DC power supply (the included AC adapter) connected to the DC input or from the internal rechargeable battery pack. To use the AC adapter, plug it into a wall outlet of the appropriate voltage and insert the DC plug into the DC power input of the 1522 (see Figure 2.) The battery pack must first be fully charged prior to using the AC adapter (see Section 6.1).

4.6 Switch the Power On

Power is switched on and off with the power button located below and to the left of the display. To switch the power on, hold the power button down for at least three seconds and release. (To switch power off, momentarily press the power button again.) The instrument takes a few seconds to power up, initialize itself, and begin normal operation. During initialization the lower line of the display shows the manufacturer, model number, firmware version, and the state of battery charge or the message "External power" if the AC adapter is attached. If the thermometer readout or probe calibration have expired, the messages "Prb cal expired" or "Mtr cal expired" are displayed. The 1522 reads important information about the attached probe from the INFO-CON connector that is used to calculate temperature.

The 1522 then performs a memory check of critical parameters, such as the calibration parameters CAL1 and CAL2. During this check the lower line of the display reads "Checking Memory". If a "Memory Error" or "Memory Recover" message is displayed, see Section 12.1, Troubleshooting, for additional information and instructions.

4.7 Measure Temperature

After initialization the upper line of the display begins to show temperature measurements sensed by the probe. Place the probe into the object where you

want to measure the temperature. DO NOT force the probe or otherwise allow it to be bent, stressed, or overheated. It can be easily damaged if misused. For further suggestions on handling the probe and using the 1522 and probe to measure temperature accurately, see Section 6.5. For information on the various modes of operation of the 1522 see Section 7.

5 Parts and Controls

The functions of the various features of the 1522 are described below.

5.1 Front View

The front of the 1522 features the LCD display and control buttons.



Figure 1 Front View

Display-The display shows the current temperature (or resistance) measurement on the large numeric upper portion of the display. It can also show a variety of information on the smaller alphanumeric lower portion such as minimum, maximum, delta(x), and other instrument settings.

Power and Backlight button-This button turns the instrument on or off. If the power is on, pressing the button for three seconds toggles the backlight on or off (see Section 6.3). **Note:** using the backlight drains the battery more quickly.

ENT (enter) button-This button is pressed to accept changes to a setting and, in some modes, to store the most recent measurement.

CLR (clear) button-This button cancels changes to a setting and in the MIN/MAX mode resets the minimum and maximum to the last measurement.

Up and Down buttons-These buttons are used to change values and settings.

MODE button-This button advances through operating modes and programming functions (see Section 7).

5.2 Top and Side View

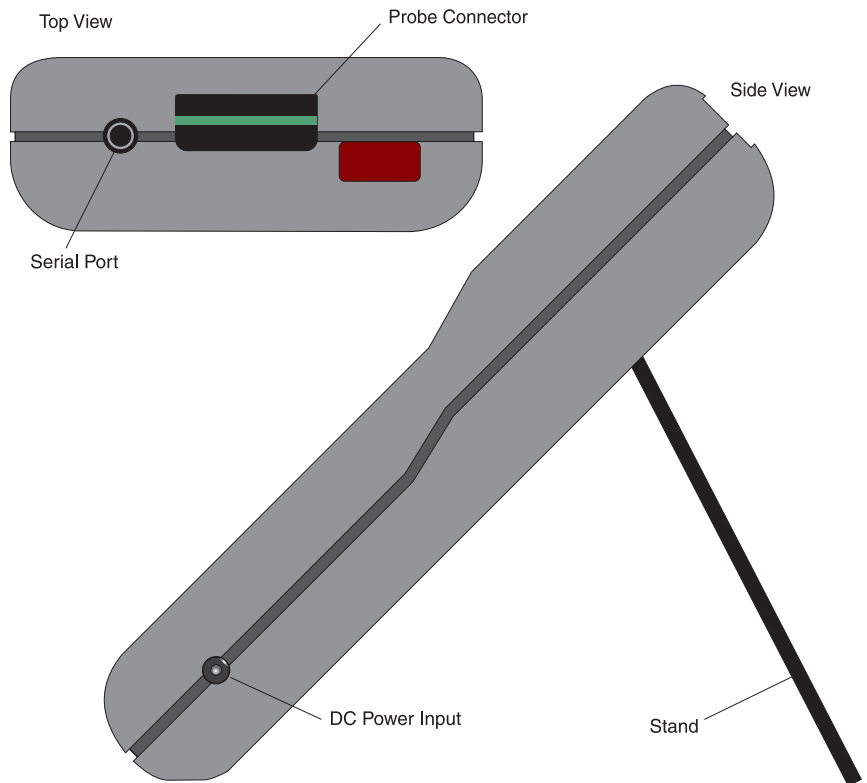

Figure 2 Top and Side View

The top and side of the 1522 feature the probe connector, DC power input, and serial port.

Probe Connector - At the top of the thermometer readout is the opening where the probe connector is inserted. The probe must be connected using an INFO-CON probe connector to measure temperature (see Section 6.6).

DC Power Input - The AC adapter plugs into the DC power input to recharge the battery and to power the instrument while the battery is being charged (see Section 6.2).

Serial Port - The RS-232 serial port provides a means of connecting the 1522 to a computer or a printer using the included serial cable (see Section 8). The baud rate is fixed at 2400 baud, the linefeed is fixed to ON (all carriage returns

are followed by a linefeed, ASCII decimal 10), and the duplex is fixed to Half disabling the echo.

5.3 Back View

See Figure 4 on page 21.

Stand - The stand at the back of the 1522 can be flipped down to prop up the instrument for better viewing.

Battery Compartment - Behind the stand is the compartment that contains the battery pack. The battery pack can be accessed if necessary by opening the battery cover with a small Philips screwdriver (see Section 6.1).

Serial Number Label - Also behind the stand is the serial number label that uniquely identifies the instrument.

5.4 Internal Features

The significant components inside the 1522 are described here.

Battery - The 1522 has an internal rechargeable battery pack that can be recharged by the AC adapter without removing the battery. It can be used and recharged many times. If necessary, it can be easily removed and replaced (see Section 6.1).

Micro-controller - The 1522 uses a micro-controller to control all its functions. The micro-controller manages the measurement process, retrieves measurement data from the analog-to-digital converter (ADC), places measurements and other information on the display, senses button actions, reads battery status information from the power control circuit, and handles communications through the serial port.

Power Control Circuit - The power control circuit manages the electrical power that drives all the circuits. It handles switching between the two sources of power (DC input and battery pack), regulates voltages, monitors the state of battery charge, and manages battery charging.

Analog-to-Digital Converter and Measurement Circuit - The ADC takes an analog signal produced by the probe and converts it to a digital value that can be read by the micro-controller. The ADC used in the 1522 was selected for its excellent resolution, linearity, and stability. The measurement circuit built around the ADC was carefully designed for accuracy and stability to match the ADC. The measurement circuit allows complete rejection of probe wire resistance effects that would otherwise seriously limit accuracy. Offsets from sources such as thermoelectric EMF are also completely rejected. This is done using a current reversal technique with the probe current alternating at a rate of one cycle per second. Self-heating is minimized by using low sensing currents. For PRTs the current is only 0.5 mA. For thermistors the current is only 0.005 mA.

5.5 Accessories

The 1522's accessories and their features are described here.

AC Adapter - The AC adapter recharges the internal battery pack and may also be used to supply power to operate the 1522 while the battery is being charged (see Section 6.2).

Serial Cable - The serial cable is used to connect a computer or a printer to the 1522 through its serial port (see Section 8).

INFO-CON Connector - Hart's unique INFO-CON connector allows the probe to be easily attached and detached. It contains a memory device that **stores information about the probe and automatically transfers this data to the 1522 when the probe is attached**. This ensures that the settings used to measure and calculate temperature always match the probe being used (see Section 6.6).



Figure 3 INFO-CON Connector

Probe - The probe acts as the temperature sensor. Its resistance depends on its temperature. The 1522 precisely measures the resistance of the probe and uses the coefficients stored in the INFO-CON connector to calculate its temperature (see Section 6.5). The following probe options are available.

Ordering Information					
Model	Type	Range	Size	Cal Uncertainty and Repeatability†	Typical Drift† (1 year)
5626	Pt-100 Ohm, 4-wire	-200 to 660°C	1/4" x 12" or 15" (6.35 x 305 or 381 mm)	±0.015°C	±0.03°C
5628	Pt-25 Ohm, 4-wire	-200 to 660°C	1/4" x 12" or 15" (6.35 x 305 or 381 mm)	±0.015°C	±0.03°C
5614	Pt-100 Ohm, 4-wire	-200 to 450°C	1/4" x 12" (6.35 x 305 mm)	±0.025°C	±0.01°C

Ordering Information					
Model	Type	Range	Size	Cal Uncertainty and Repeatability†	Typical Drift† (1 year)
5613	Pt-100 Ohm, 4-wire	-200 to 300°C	3/16" x 6" (4.76 x 152 mm)	±0.025°C	±0.01°C
5612	Pt-100 Ohm, 4-wire	-200 to 450°C	3/16" x 9" (4.76 x 229 mm)	±0.025°C	±0.01°C
5627-6	Pt-100 Ohm, 4-wire	-200 to 300°C	3/16" x 6" (4.76 x 152 mm)	±0.035°C	±0.13°C
5627-9	Pt-100 Ohm, 4-wire	-200 to 450°C	3/16" x 9" (4.76 x 229 mm)	±0.035°C	±0.13°C
5627-12	Pt-100 Ohm, 4-wire	-200 to 450°C	1/4" x 12" (6.35 x 305 mm)	±0.035°C	±0.13°C
5610-6	10K-ohm Thermistor	0 to 110°C	1/8" x 6" (3.2 x 152 mm)	±0.02°C	±0.01°C
5610-9	10K-ohm Thermistor	0 to 110°C	1/8" x 9" (3.2 x 229 mm)	±0.02°C	±0.01°C
5611	10K-ohm Thermistor	0 to 110°C	0.07" x 0.55" (1.8 x 14 mm)	±0.02°C	±0.01°C
5611T	10K-ohm Thermistor	0 to 110°C	0.11" x 1.1" (2.8 x 28 mm)	±0.02°C	±0.01°C
5640	4K-ohm Thermistor	0 to 60°C	1/4" x 9" (6.35 x 229 mm)	±0.0015°C	±0.005°C
5622-05	Pt-100 Ohm, 4-wire	-200 to 350°C	0.5 x 100 mm	±0.035°C	±0.15°C
5622-10	Pt-100 Ohm, 4-wire	-200 to 350°C	1.0 x 100 mm	±0.035°C	±0.15°C
5622-16	Pt-100 Ohm, 4-wire	-200 to 350°C	1.6 x 100 mm	±0.035°C	±0.15°C
5622-32	Pt-100 Ohm, 4-wire	-200 to 350°C	3.2 x 100 mm	±0.035°C	±0.15°C
5618-6	Pt-100 Ohm, 4-wire	-200 to 500°C	1/8" x 9" (3.2 x 152 mm)	±0.035°C	±0.01°C
5618-9	Pt-100 Ohm, 4-wire	-200 to 500°C	1/8" x 9" (3.2 x 229 mm)	±0.035°C	±0.01°C
5618-12	Pt-100 Ohm, 4-wire	-200 to 500°C	1/8" x 9" (3.2 x 305 mm)	±0.035°C	±0.01°C

†Probe performance specifications may vary based on use, handling, and calibration. Call an Authorized Service Center (see Section 1.3) for more complete specifications.

LogWare Software - The LogWare software are data acquisition software packages that can be used with your thermometer to collect and graph data. The software also allows the user to download data logged from the instrument's memory to a computer and access to some of the instrument's features.

Carrying Cases - There are two types of cases available for your 1522 thermometer readout. The Model 9318 case is a hard case for carrying the thermometer readout and a 12" probe. The Model 9321 case is a soft case with a belt clip and a probe slot.

6 General Operation

This section explains the details of the operation of the 1522 with its components and accessories.

6.1 Battery

The 1522 has a built-in nickel-metal-hydride battery pack that can power the instrument for about 18 hours before needing to be recharged. The battery discharges much more quickly if the display backlight is used. The battery charge remaining or the message “External Power” is shown on the display when the instrument is switched on. The battery percentages are approximate and should be used as general guidelines when determining the length of charge remaining.

The battery is recharged *in situ* (while in place) using the AC adapter. Plug the AC adapter into an AC socket of the appropriate voltage as noted on the AC adapter (normally 115V, optionally 230V). Connect the DC plug of the adapter into the DC input of the 1522 located on the right side. The battery charges as necessary whether or not the instrument is switched on. The power control circuit inside the instrument manages battery charging and stops charging the bat-

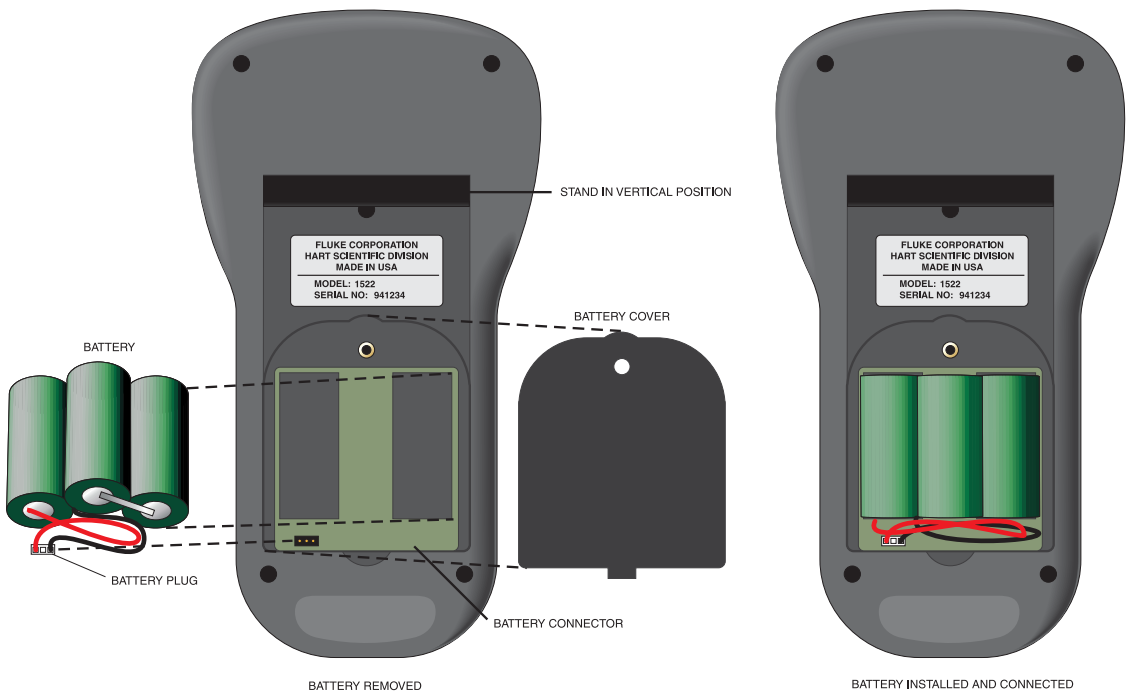

Figure 4 Battery Installation

tery automatically when it's fully charged. It normally takes about four hours to fully charge the battery. The instrument can be operated while the battery is being charged.



CAUTION: DO NOT leave the AC adapter plugged in for more than 24 consecutive hours or, the battery life could be degraded.

The battery pack can be used for a minimum of 500 charge-discharge cycles before needing to be replaced. Replacement battery packs are available from the manufacturer. The battery pack can be easily removed and replaced in the field by following this procedure:

1. Power the 1522 off and unplug the AC adapter.
2. With the 1522 facing down, lift the stand to expose the battery cover (see Figure 4). Remove the battery cover screw with a small Philip's screwdriver. Remove the battery cover to access the battery pack.
3. Remove the battery pack by gently disconnecting the battery plug from the connector. **Note the orientation of the battery plug on the connector.**
4. Attach the polarized plug of the new battery pack onto the connector in the same direction as before (see Figure 4 on page 21). Place the battery pack in the battery compartment.
5. Replace the battery cover and screw.
6. Plug in the AC adapter and charge the new battery for a minimum of four hours for its initial charge.



WARNING: Used batteries must be disposed of properly. Check your local regulations for additional information. Never dispose of batteries in fire as this may result in explosion with the possibility of personal injury or property damage.

6.2 DC Power Source

The DC power source provides power to charge the battery. It can also be used to power the 1522 while the battery is being charged. The AC adapter provided with the 1522 is intended to be used for these purposes. Use only the AC

adapter supplied by Hart Scientific. The DC power source plugs into the DC power input on the right side of the 1522.

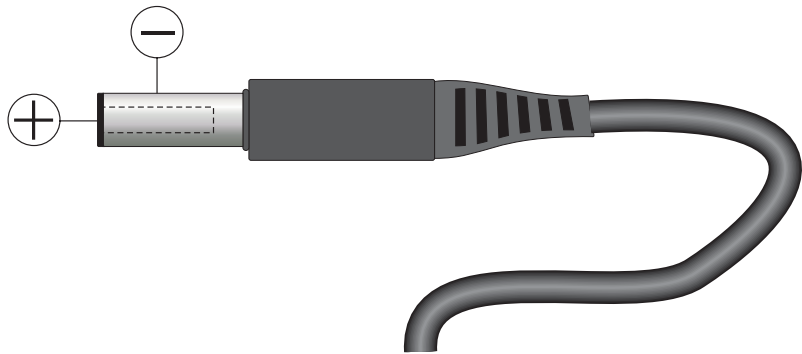

Figure 5 12V DC Power Source Polarity



WARNING: The AC adapter contains high voltage circuits that could present danger of electric shock or fire if exposed. If the AC adapter is damaged in any way or becomes hot, discontinue its use immediately, disconnect it from any AC supply, and have it replaced. Do not attempt to open, repair, or continue using a damaged or defective AC adapter.

6.3 Power Button

The power button controls power to the instrument and operates the backlight. The following table summarizes the power button functions.

Function	Action
Power on	Press and the power button for at least three seconds
Power off	Press the power button momentarily (1/2 second or less) while the power is on
Backlight on	Press and hold the power button for three seconds or more while the power is on and the backlight is off
Backlight off	Press and hold the power button for three seconds or more while the backlight is on

6.4 Display and Backlight

The display shows measurement data and other relevant information depending on the selected mode.

The upper part of the display continually shows the most recent measurement with large digit format. A new measurement is produced and displayed every

second. The display unit associated with the measurement is shown in smaller type to the right of the measurement. The possible display units are degrees Celsius (C), resistance in ohms (Ω), degrees Fahrenheit (F), Kelvin (K), and degrees Rankine (R). The display units can be easily changed accessing the Units mode (see Section 7.6).

The lower part of the display has various functions depending on the selected mode. It has smaller alphanumeric characters. It can be used to display minimum and maximum measurements, delta(x) measurements, or measurements stored in memory. It is also used to view and set various operating parameters. The mode is easily changed using the **MODE** button. (See details on the various modes beginning with Section 7.)

The display has a backlight that can be switched on for better viewing in dim light. The backlight is switched on and off by pressing and holding the power button for three seconds (see Section 6.3 above). **Note:** The battery discharges more quickly when the backlight is used.

6.5 Probe

The probe is used to sense temperature and attaches to the 1522 using a Hart INFO-CON probe connector that plugs into the top of the instrument. **The probe connector must be properly programmed with the correct characteristics of the probe for measurements to be accurate (see Section 6.6).**

The 1522 can be used with various types of PRT and thermistor probes:

- ITS-90 calibrated 25 Ω or 100 Ω PRT
- IEC-751 or DIN-43760 PRT (RTD)
- Callendar-Van Dusen calibrated 100 Ω PRT
- YSI-400 series or equivalent 2252 Ω thermistor
- Steinhart-Hart thermistor polynomial; nominal R(25°C) 2k Ω to 100k Ω

See Section 7.9.8 for details on the various probe types and their programming. The 1522 cannot be used with thermocouples.

The 1522 can be used with probes having two, three, or four wires. Three-wire probes allow partial compensation for wire resistance. The 1522 measures three-wire probes using the following sequence. It measures the sensor resistance, including the lead resistance in C2. The 1522 then directly measures the resistance in the C1 lead of the sensor and subtracts the measured C1 lead resistance from the measured sensor resistance (including the C2 lead resistance) to obtain the sensor resistance used to calculate temperature. **Note:** This sequence assumes that the lead resistance of C1 and C2 are equal. If C1 and C2 each have a different resistance value, there will be an error in the calculated sensor resistance equal to this difference. Four-wire probes allow complete rejection of wire resistance and should be used when the best accuracy is desired. The 1522 wire setting must be set to match the actual number of wires of the probe (see Section 7.9.14).

Temperature is generally sensed at the tip of the probe. To get an accurate temperature measurement the probe sheath should be well immersed, with adequate depth and fit, into the medium to be measured.



CAUTION: *Probes are fragile devices that can be easily damaged by mechanical shock, overheating, and absorption of moisture or fluids in the wires or hub. Damage may not be visibly apparent but nevertheless can cause drift, instability, and loss of accuracy. Observe the following precautions:*

Do not allow probes to be dropped, struck, bent, or stressed.

Do not overheat probes beyond their recommended temperature range.

Do not allow any part of the probe other than the sheath to be immersed in fluid.

Do not allow the probe hub or wires to be exposed to excessive temperatures.

Keep the probe wires clean and away from fluids.

6.6 INFO-CON Connector

The probe connects to the top of the 1522 using a Hart INFO-CON connector (see Figure 3 on page 19). The probe connector fits snugly and locks into place when it is fully inserted. The connector includes a memory device that stores the unique characteristics of the probe, allowing the instrument to measure temperature accurately. Generally, the probe is purchased with the connector attached and programmed by the factory. Connectors can be purchased separately and installed onto probes by the user. The INFO-CON can be programmed directly from the 1522.

If it is necessary to install the INFO-CON onto a probe in the field, follow the diagram below for connecting the wires of the probe to the connector terminals.



CAUTION: *Before opening the INFO-CON case, be sure to be grounded with an ESD strap to avoid damaging the memory chip.*

For four-wire probes, one pair of wires attaches to terminals C1 and P1 and the other pair attaches to terminals C2 and P2. (C1 and C2 source current and P1 and P2 sense the potential.) If a shield wire is present, it should be connected to the GND terminal (see Figure 6).

A two-wire or three-wire probe can also be used with the instrument. The two-wire probe is connected by one wire to the C1 and P1 shorted terminals and the other wire to the C2 and P2 shorted terminals. Recognize that accuracy may be significantly degraded using a two-wire connection because of wire resistance. A three-wire probe is connected by attaching the common wires to the

C1 and P1 terminals and the other single wire to the C2 and P2 terminals (which are shorted together).

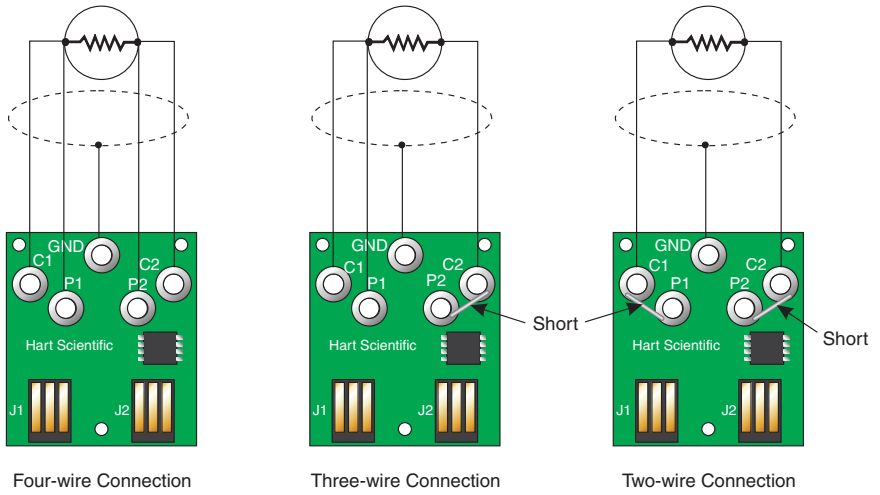

Figure 6 Probe Wiring Diagrams

7 Display Functions

The instrument operates in any of several modes which determine what information is visible in the lower alphanumeric portion of the display. The **MODE** button sequences through the menu functions. This button can be pressed repeatedly until a desired mode is set. The various modes are listed below in the order they appear. Also refer to Figure 7.

Blank - No data shown

Min/Max - Display minimum and maximum measurements (**CLR** to reset)

Demand Logging - Store readings (up to 100) on demand in the memory registers

Auto Logging - Store readings (up to 10,000) automatically in memory at user selected intervals

Delta(x) - Display delta from reference measurement (**ENT** to set reference)

Units: C/Ω/F/K/R - Set the units of measurement

Rate: 0000 - Set the period for serial transmission

Resol: XXX.XXX - Set the display resolution

CAL MODE - Set probe and instrument calibration parameters (**MODE** button must be held for three seconds)

Note: Units, Rate, and Resol are temporary modes. The instrument returns to Blank mode if left in any of these modes when the power is cycled.

Each of these operating modes is described in the sections that follow.

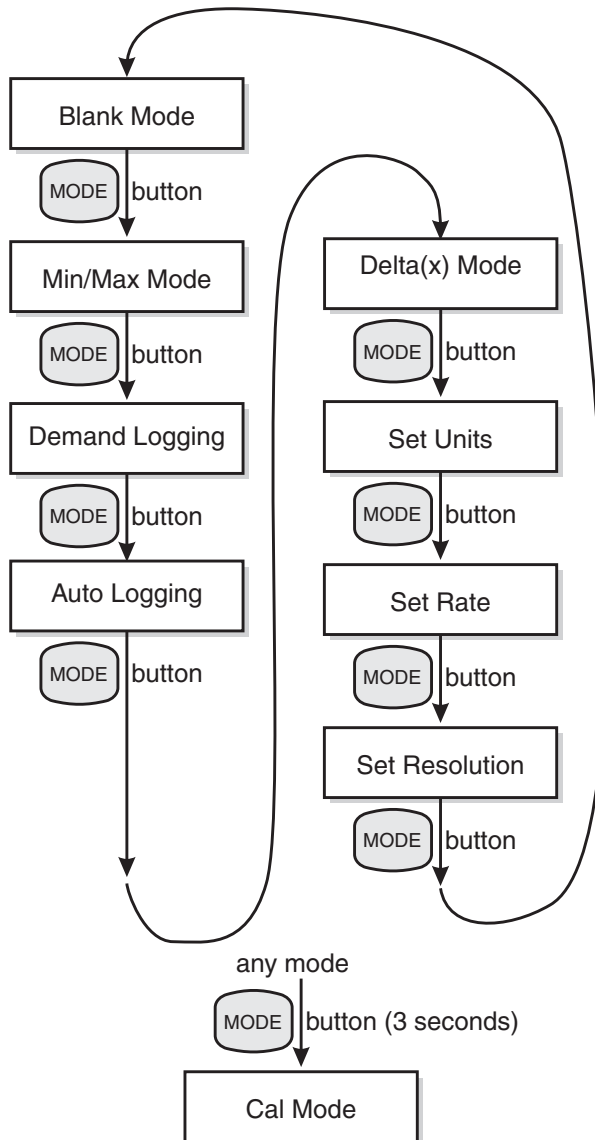

Figure 7 Operating Modes Flowchart

7.1 Blank Mode

This mode is identified by “Blank” that temporarily appears on the display.

In this mode nothing appears on the alphanumeric portion of the display. Use this mode if you are only interested in the latest measurements and want to simplify the appearance of the display.

The message “Prb cal expired”, “Mtr cal expired”, “Recharge Needed”, or “Probe is locked” may be displayed.

7.2 Min/Max Mode

This mode is identified by “Min/Max” that temporarily appears on the display.

In this mode the maximum and minimum measurements taken since the last time the function was cleared appears on the display. The minimum appears on the left and the maximum appears on the right. The resolution of the displayed values match the current setting of the thermometer as set in the Resolution mode (see Section 7.8). Pressing the **CLR** button at anytime while in this mode clears the minimum and maximum values setting them to the last measurement. Both the minimum and maximum are reset to 0°C (32°F) when the instrument is powered up.

Refer to Section 7.6 concerning how changing units affects Min/Max.

The message “Prb cal expired”, “Mtr cal expired”, “Recharge Needed”, or “Probe is locked” may be displayed.

7.3 Demand Logging

This mode is identified by "Demand Logging" which temporarily appears on the screen.

In this mode up to 100 temperature readings with units, date, time, and label can be stored as required. This mode also allows all on-demand data points to be viewed. The logged values can be downloaded to a PC using the serial port.

7.3.1 Demand Log Label and Data Storage

This function allows data to be logged on-demand and also allows data to be viewed. The message "Press ENT to log" appears on the screen. Press the **ENT** button to store a label with the logged value and to log the current reading into the on-demand memory. Press the **Up** or **Down** button to scroll through the previously stored values. Press the **CLR** button to cancel storing the reading and to advance to the next function.

Continue pressing the **ENT** button to log additional readings. The labels should be pre-loaded into the instrument before performing on-demand logging. If no label is chosen the default label is applied which is the number (between 1 and 100) of the reading. After choosing a label, the label and the reading are displayed on the second line of the display. The on-demand readings can then be scrolled through using the **Up** and **Down** buttons.

The labels can be pre-loaded using the Windows® HyperTerminal or other serial communications program and the command `LBnn[=nnnnnnnn]` as described in Section 8.2.1. The labels can also be pre-loaded using the serial port with the 9934 LogWare or 9935 LogWare II software available by contacting an Authorized Service Center (see Section 1.3 on page 4).

7.3.2 Dump Data?

Press the **CLR** button anytime while in Demand Log Mode to enter this function. This function allows the user to download the stored values using the serial port or print the data to a serial printer. To download using the serial port, the 1522 must be connected to a computer using the serial cable sent with the instrument at the time of purchase. Windows® HyperTerminal or other serial communications program must be running. Set HyperTerminal or other serial communications program to use the correct COM port and to operate at 2400 baud, 8 data bits, 1 stop bit, no parity, and no flow control. Once the communications program is running and configured correctly, press the **CLR** button on the 1522 until the second line of the display reads, "Dump Data? No". Select "Yes" using the **Up** or the **Down** buttons and then press the **ENT** button. The demand logged data begins displaying in the terminal window and the second line displays "Downloading data".

The instrument advances to the next function when all values have been downloaded. Pressing the **CLR** button before or during downloading causes the download to stop and advances to the next function. To exit the Demand Log Mode, press the **MODE** button.

9934 LogWare or 9935 LogWare II software provide a utility to view and change logging labels.

7.3.3 Clear Log?

This function clears the on-demand memory. After 100 readings have been stored in the on-demand memory the 1522 does not allow any more readings to be logged until the on-demand memory is cleared. Press the **Up** and **Down** until "Yes" appears and then press the **ENT** button to clear the on-demand memory. Pressing the **CLR** button at anytime advances to the next function without clearing the memory.

7.4 Auto Logging

This mode allows data logging to occur automatically at user selected intervals. Up to 10,000 temperature readings can be stored into memory with units, time, date, and label. Multiple log sessions are appended to the memory until the memory is full. The log sessions are grouped by the pre-loaded labels.

7.4.1 Clear Autolog?

This function clears the memory of all autologged data. Once the 1522 has logged 10,000 readings, further automatic logging is prevented until the memory has been cleared. Pressing the **CLR** button cancels the "Clr Autolog?" function and advances to the next function. Pressing the **ENT** button also advances to the next function.

7.4.2 Log Rate

This function configures the rate at which data is stored into the memory of the 1522. The following rates are available: 1, 5, 10, 15, 30, or 60 seconds, 2, 5, 10, 15, 30 or 60 minutes. Scroll through the rates using the **Up** or **Down** buttons until the desired rate is shown and then press the **ENT** button to select the rate. The 1522 advances to the next function. Pressing the **CLR** button at any time also advances to the next function.

7.4.3 Autolog Label

A label is stored with each logged reading. Up to 25 labels should be pre-loaded into the unit through the serial port prior to autologging. These labels can then be used to differentiate separate autologging sessions. The same label is applied to every data point once autologging is initiated. To change this label, autologging must be stopped and a new label selected. When selecting labels, press the **ENT** button to store the displayed label or press the **CLR** button to revert to the previously selected label.

The labels can be pre-loaded using Windows® HyperTerminal or other serial communications program and the command `LBnn=[nnnnnnnn]` as described in Section 8.2.1. The labels can also be pre-loaded using the serial port with the 9934 *LogWare* or 9935 *LogWare II* software available by contacting an Authorized Service Center (see Section 1.3 on page 4).

7.4.4 Autologged Data Storage

This function stores values to the memory of the unit for future download. Each reading is stored with units, date, time and label. Up to 10,000 readings can be stored in memory.

The message "ENT to start log" appears on the 1522 display. Press the **ENT** button to begin autologging. Press the **CLR** button to cancel and advance to the next function.

After pressing the **ENT** button the 1522 begins to log data automatically at the rate specified in the Log Rate (see Section 7.4.2) and with the label chosen in Autolog Label (see Section 7.4.3). The 1522 display alternates between the message "ENT to stop log" and "Logging NN% Full" where NN is a number between 0 and 100 and shows the percentage of memory that contains autologged data. When data is being logged, all buttons are disabled except for the **ENT** button.

Press the **ENT** button to stop autologging and to advance to the next function.

7.4.5 Dump Data?

This function allows the user to download the autologged data using the serial port or print the downloaded data to a serial printer. To download using the serial port, see Section 8 of this guide before selecting “Yes” when prompted by Dump Data.

The autologged data can also be downloaded using 9934 *LogWare* or 9935 *LogWare II* software. Using this software, the autologged data can be downloaded in binary or ASCII format into a single ASCII text file or multiple ASCII text files based on the labels. The approximate download time through the serial port is 22 minutes for 10,000 readings.

The *LogWare* software also provides a utility to view and change logging labels.

7.5 Delta(x) Mode

This mode is identified by “Delta(x)” that temporarily appears on the display.

In this mode the delta between the measurement and a previously stored reference value appears on the right side of the display. The reference value appears on the left. The resolution of the reference value may be changed using the Resolution mode (see Section 7.8) if necessary. The **ENT** button stores the present measurement as the reference value.

Refer to Section 7.6 concerning how changing units affects Delta(x).

The message “Prb cal expired”, “Mtr cal expired”, “Recharge Needed”, or “Probe is locked” may be displayed.

7.6 Units

This mode is identified by “Units: C/ Ω /F/K/R” that appears on the display.

This mode allows you to select the unit of measurement: C for degrees Celsius, Ω for resistance in ohms, F for degrees Fahrenheit, K for Kelvin, and R for Rankine. The **Up** and **Down** buttons are used to select one of the displayed units. The underline cursor indicates which of the units is selected. The **ENT** button stores the selection. If the **MODE** button or **CLR** button is pressed without pressing **ENT** the unit remains unchanged. Once the unit is selected, subsequent measurements will appear in that unit. After the Min/Max and Delta(x) modes are initiated, their values are automatically converted when changing units between °C, K, °F, or R. Changing units from Ω to any temperature unit or visa versa, reinitializes the Min/Max and Delta(x) modes. **Any previously Min/Max and Delta(x) values are lost.**

Note: When measuring in units of ohms, make sure that the appropriate probe type has been selected in the Cal Mode menu. For example, to measure a resistor between 0 and 400 ohms, set the units to ohms and select the appropriate probe type such as "CVD". To measure a resistor between 400 and 500K ohms, set the units to ohms and select the appropriate probe type such as "THERM".

7.7 Rate

This mode is identified by "Rate: 00000" that appears on the display.

This mode allows you to set the samples that are transmitted from the serial port. The sample for a 2-wire and a 4-wire probe is approximately one second and for a 3-wire probe is approximately two seconds. For example, if the rate is set to 2, every other sample is sent to the serial interface. A value of 0 disables transmission. The **Up** and **Down** buttons are used to increase or decrease the value for the underlined digit. The **ENT** button moves to the next digit. If the **ENT** button is pushed when the *last digit is underlined*, the setting is stored. If the **MODE** button or **CLR** button is pressed, the value remains unchanged. Once the value is set measurements will be transmitted from the serial port at the given interval.

7.8 Resolution

This mode is identified by "Resol: XXX.XXX" that appears on the display.

This mode allows you to set the resolution of measurements to one, two, or three digits after the decimal point. The **Up** and **Down** buttons are used to increase or decrease the resolution setting. The **ENT** button stores the setting. If the **MODE** button or **CLR** button is pressed, the setting remains unchanged. Once the resolution is set, measurements are displayed and transmitted from the serial port at the given resolution, if possible. The resolution may be reduced if necessary for large values of temperature or resistance.

7.9 CAL MODE

The calibration menu contains functions for setting probe and instrument calibration parameters. Press and hold the **MODE** button for three seconds to enter the calibration menu. "CAL MODE" appears on the display. Press the **ENT** button to advance.

When editing any parameter, be sure to press the **ENT** button through the entire line of alphanumeric characters to ensure that the edits are stored. Pressing any button other than the **ENT** button advances to the next function without storing the new value.

If a probe parameter is edited, the new parameter value is uploaded into the INFO-CON probe connector when the CAL Mode is exited by pressing the **MODE** button or after scrolling through the menu and leaving the PDue parameter (see Section 7.9.16). The message "Uploading params" is displayed.

After the parameters have been uploaded into the INFO-CON probe connector, the meter advances to the next menu item. Always check to ensure that the parameters have been written to the INFO-CON connector by disconnecting the probe or by turning the instrument off and on and then rechecking the parameters.

The calibration menu is entered by pressing and holding the MODE button for three seconds. "CAL MODE" appears on the display. Press the ENT button to advance. Press the MODE button while in the calibration menu to exit and to advance to the display mode that follows the display mode that was active before the CAL Mode was entered.

The functions contained in the CAL Mode are listed below in the order they appear. In any of the functions, the ENT button stores the displayed value or selection and advances to the next function. The CLR button can be used to cancel changes to a value or selection and to skip to the next function.

Use the ENT button to move from Mtr Due to Prb Due and then to Time. Use the CLR button to quickly advance through the remaining functions. Many of the functions are in the passcode protected part of the CAL Mode. You must enter the correct passcode to access those functions (see Section 7.9.4).

- Mtr Due** - View the date the instrument is due for calibration
- Prb Due** - View the date the probe is due for calibration
- Time** - View and set the real-time clock time-of-day
- Passcode** - Enter the passcode to advance to the protected functions
- Date** - View and set the real-time clock date
- Probe Lock** - Lock or unlock operation of the unit with the current probe only
- Prb #** - Set the probe serial number
- Prb Type** - Select the probe type and temperature calculation
- R(.01)** [ITS-90 only] - Sets the R(273.16K) probe coefficient
- a** [ITS-90 only] - Set the a5, a6, a7, a8, a9, a10, or a11 probe coefficient
- b** [ITS-90 only] - Set the b5, b6, b7, b8, or b9 probe coefficient
- c** [ITS-90 only] - Set the c6, or c7 probe coefficient
- d** [ITS-90 only] - Set the d probe coefficient
- a4** [ITS-90 only] - Set the a4 or a5 probe coefficient
- b4** [ITS-90 only] - Set the b4 or b5 probe coefficient
- R(0)** [CVD only] - Set the R0 probe coefficient
- Alpha** [CVD only] - Set the alpha probe coefficient
- Delta** [CVD only] - Set the delta probe coefficient
- Beta** [CVD only] - Set the beta probe coefficient
- b0** [Therm only] - Set the b0 probe coefficient

- b1** [Therm only] - Set the b1 probe coefficient
- b2** [Therm only] - Set the b2 probe coefficient
- b3** [Therm only] - Set the b3 probe coefficient
- Probe Wires** - Set the number of wires of the probe
- PCal** - Set the probe calibration date
- PDue** - Set the probe calibration due date
- Filter** - Set the digital filter time constant
- MCal** - Set the instrument calibration date
- MDue** - Set the instrument recalibration due date
- CAL1** - Set the instrument's PRT range calibration parameter
- CAL2** - Set the instrument's thermistor range calibration parameter

The calibration functions are described in detail in the following subsections.

7.9.1 **Mtr Due**

This function displays the date the instrument is due for calibration. The date cannot be changed with this function. To edit the meter due date, refer to Section 7.9.19.

7.9.2 **Prb Due**

This function displays the date the probe is due for calibration. The date is stored in the INFO-CON probe connector. The date cannot be changed with this function. To edit the probe due date, refer to Section 7.9.16.

7.9.3 **Time**

This function displays and sets the time of day. The time is always set, displayed, or printed in 24-hour format. To set each time segment, use the **Up** and **Down** buttons. Use the **ENT** button to move between time segments and to save the changed values. The **CLR** button moves to the next function.

7.9.4 **Passcode**

All functions below this function are protected by a passcode so that only authorized users can access them. The passcode must be entered correctly to continue. If the passcode is entered incorrectly or the **MODE** or **CLR** buttons are pressed, the message "Invalid Passcode" is displayed and the instrument is returned to the display mode that follows the function that was active when the CAL Mode was entered.

Each individual instrument has its own unique passcode. The passcode number is given on a notice provided with this instrument. The equipment manager is responsible for keeping the passcode number stored in a proper location and ensuring that it is not lost or forgotten. If necessary, the passcode can be restored by contacting the manufacturer. To enter the passcode, use the **Up** and

Down buttons to set each digit of the passcode and the **ENT** button to move to the next digit on the right. Press **ENT** twice when all digits are entered to move to the next function. If the passcode is entered correctly, the next function in the CAL Mode appears.

7.9.5 Date

This function displays the present date and allows it to be changed. This function is placed in the pass-code protected part of the CAL Mode since the calibration due warning messages depend on the present date as well as the stored due dates. Use the **Up** and **Down** buttons to set each date segment and the **ENT** button to move between the date segments. Press **ENT** when all digits are entered to save the changed values. The **CLR** button moves to the next function without saving the changed values.

7.9.6 Probe Lock

This function locks or unlocks operation of the unit with the presently connected probe only. To set probe lock, use the **Up** and **Down** buttons to select ON or OFF and press the **ENT** button to store the selected setting and continue.

If probe lock is set to ON, the serial number of the currently attached probe is stored. The instrument can only be used to display temperature with the probe that was attached when the probe lock was set ON. If probe lock is ON and a different probe is attached, the instrument returns to Blank Mode and displays the message "Probe is locked". Measuring is disabled. Probe lock ON also disables access to the probe parameters that follow in the menu.

If probe lock is OFF, the instrument can be used with any probe. To lock the instrument with a new probe, set probe lock OFF, attach a new probe, and then set probe lock ON again.

7.9.7 Prb

This function displays the serial number of the probe and allows it to be set. **The probe serial number is stored in the INFO-CON probe connector.** Use the **Up** and **Down** buttons to set each digit and the **ENT** button to move to the next digit on the right. Press **ENT** when all digits are entered.

7.9.8 Prb Type

This function specifies the type of probe and its characterization. It allows the instrument to use the appropriate algorithm to calculate temperature from the measured resistance of the probe. The functions that follow the probe conversion function for setting probe characterization coefficients depend on the selected probe type. The table below lists the probe types and the corresponding coefficients.

Probe Type	Description	Coefficients
------------	-------------	--------------

ITS-90	PRTs calibrated to ITS-90	R(.01), a, b, c, d, a4, and b4
IEC751	PRTs (RTDs) conforming to IEC-751	none
CVD	PRTs characterized by the Callendar-Van Dusen equation	R0, Alpha, Delta, and Beta
YSI-400	Thermistors matching the YSI-400 series	none
THERM	Thermistors characterized by the thermistor polynomial	b0, b1, b2, and b3

Each of the conversion options is explained in the following sections along with their associated coefficients, when applicable. The probe type and associated coefficients are stored in the INFO-CON probe connector. Use the **Up** and **Down** buttons to select the probe type and the **ENT** button to store and continue.

Each of the coefficients that follow the probe type are set in the usual way. Use the **Up** and **Down** buttons to set each digit and the **ENT** button to move to the next digit to the right. Press **ENT** when all digits are entered.

7.9.9 ITS-90

The ITS-90 type is for PRTs calibrated and characterized using the *International Temperature Scale of 1990* equations. Probes that use this linearization curve generally have excellent accuracy (0.005 to 0.025°C), a wide operating range (–180°C to 420°C or higher). The coefficients that appear when ITS-90 is selected are “R(.01)”, “a”, “b”, “c”, “d”, “a4”, and “b4”. These should be set to the coefficient values that appear on the PRT calibration certificate according to the following table.

All coefficients, except R(.01), have values greater than or equal to –1 and less than or equal to +1, i.e. $-1 \leq \text{value} \leq +1$. The instrument does not allow values outside this range to be entered. If a value less than –1 is entered, the coefficient defaults to –1. If a value greater than +1 is entered, the coefficient defaults to +1.

Unused coefficients must be set to 0.

Coefficients	Certificate Value
R(.01)	Rtpw
a	a5, a6, a7, a8, a9, a10, or a11
b	b5, b6, b7, b8 or b9
c	c6 or c7
d	d
a4	a4 or a5
b4	b4 or b5

Consider the following examples.

Example 1:

A PRT was calibrated to ITS-90 and its calibration certificate states values for coefficients R(273.16K), a4, b4, a8, and b8. Set the instrument's coefficients to the certificate values as follows.

Coefficients	Certificate Value
R(.01)	R(273.16K)
a	a8
b	b8
c	0.0
d	0.0
a4	a4
b4	b4

Example 2:

A PRT was calibrated to ITS-90 and its calibration certificate states values for coefficients R(273.16K), a5, and b5. Set the instrument's coefficients to the certificate values as follows.

Coefficients	Certificate Value
R(.01)	R(273.16K)
a	a5
b	b5
c	0.0
d	0.0
a4	a5
b4	b5

7.9.10 IEC751

The IEC751 probe type is for standard PRTs (RTDs) conforming to the IEC751 or DIN-43760 standards. This type of probe is generally low cost and has a wide operating range (−180°C to 420°C or higher), but has limited accuracy (0.15°C to 4°C). There are no user programmable coefficients associated with this probe type. Temperature is converted from resistance based upon the standard PRT table resident in the instrument.

7.9.11 CVD

The CVD (Callendar-Van Dusen) type is used with PRTs that have unique calibration coefficients or do not match the IEC-751 specification. This type of probe is generally low cost, has a wide operating range (−180°C to 420°C or higher), and has moderate accuracy (0.05°C to 1°C). This type uses the Callendar-Van Dusen equation to calculate temperature from resistance:

$$r(t[^\circ C]) = \begin{cases} R_0 \left\{ 1 + \alpha \left[t - \delta \frac{1}{100} \left(\frac{t}{100} - 1 \right) \right] \right\} & t \geq 0 \\ R_0 \left\{ 1 + \alpha \left[t - \delta \frac{t}{100} \left(\frac{t}{100} - 1 \right) - \beta \left(\frac{t}{100} - 1 \right) \left(\frac{t}{100} \right)^3 \right] \right\} & t < 0 \end{cases}$$

The coefficients R_0 , α , δ , and β can be set by the user using the functions “R0”, “Alpha”, “Delta”, and “Beta” respectively. When editing “Alpha” there is an assumed 10^{-3} exponent (i.e. 3.8500 is actually 0.0038500).

7.9.12 YSI-400

The YSI-400 type is for 2252Ω thermistors matching the characteristics of the YSI-400 series of thermistors. This type of probe generally is low cost, has a limited operating range (−40°C to 150°C), good accuracy (0.1°C to 0.4°C), and excellent resolution (0.002°C). There are no user programmable coefficients associated with this probe type. Temperature is converted from resistance based upon a standard YSI-400 table resident in the instrument.

7.9.13 THERM

The THERM type is for thermistors that have unique calibration coefficients or do not match the YSI-400 specification. This type of probe generally has moderate cost, a limited operating range (−40°C to 150°C), excellent accuracy (0.005°C to 0.01°C) and excellent resolution (0.002°C). This type uses the Steinhart-Hart equation in the following form:

$$R(T[K])[\Omega] = \exp[b_0 + b_1 T^{-1} + b_2 T^{-2} + b_3 T^{-3}]$$

The coefficients b0 through b3 are usually found on the calibration certificate of the probe. These coefficients are set with the functions “b0”, ”b1”, “b2”, and ”b3”. In some cases the equation is used without the b2 term. For this case, the “b2” coefficient should be set to 0. Consider the following examples.

Example 1:

A thermistor has coefficients for the equation $\ln(R)$ as a function of T given as a, b, c, and d. Set the instrument's coefficients to the Report of Calibration values as follows:

Coefficients	Report of Calibration Value
b0	a
b1	b
b2	c
b3	d

Example 2:

A thermistor has coefficients for the equation $\ln(R)$ as a function of T given as a, b, and c. Set the instrument's coefficients to the Report of Calibration values as follows:

Coefficients	Report of Calibration Value
b0	a
b1	b
b2	0.0
b3	c

7.9.14 Probe Wires

This function sets the number of connecting wires in the probe. The instrument can be used with probes that have two, three, or four wires. Three wires connecting the probe sensor instead of two allows the instrument to partially cancel

measurement error due to the resistance of the wires. With four wires the instrument can completely cancel the error. The internal measurement circuit is configured differently depending on the number of wires.

Note: The instrument tries to calculate a measurement even if the wire settings are incorrect. Therefore, the Probe Wires setting must match the actual number of wires or loss of accuracy will result (see Section 6.6). Use the **Up** and **Down** buttons to set the value and press the **ENT** button to store and continue.

7.9.15 PCal

This function shows the date the probe was calibrated and allows it to be set. The date is stored in the INFO-CON connector and is used simply for reference. Use the **Up** and **Down** buttons to set each date segment and the **ENT** button to move to the next date segment to the right. Press **ENT** when the date is correctly entered. Press **CLR** to move to the next function without changing the date.

7.9.16 PDue

This function shows the date the probe is due for calibration and allows it to be set. The date is stored in the INFO-CON connector. The probe due date is regularly checked against the present date and if the calibration has expired the user is alerted with the message “Prb cal expired”. The message disappears only when the probe is recalibrated and the probe calibration due date is set to a future date. To set the date use the **Up** and **Down** buttons to set each date segment and the **ENT** button to move to the next date segment to the right. Press **ENT** when the date is correctly entered. Press **CLR** to move to the next function without changing the date.

If any of the parameters in the CAL Mode were changed, the message “Uploading params” is displayed when exiting the PDue parameter. After the parameters have been uploaded into the INFO-CON connector, the meter advances to the next menu item.

7.9.17 Digital Filter

The digital filter helps to smooth variations in the measurements and improve resolution. A negative effect of filtering is that it tends to slow the response to changes in temperature. You can increase the filter time constant to further improve accuracy and resolution or decrease the time constant to reduce the response time. Valid values are any number between 0.0 and 60.0 seconds. A value of 0.0 disables the filter. The default is 0.0. Use the **Up** and **Down** buttons to set the value and press the **ENT** button to store and continue. Press **CLR** to move to the next function without changing the filter.

7.9.18 MCal

This function shows the date the instrument was calibrated and allows it to be set. The date is used simply for reference. Use the **Up** and **Down** buttons to set

each date segment and the **ENT** button to move to the next date segment on the right. Press **ENT** when the date is correctly entered. Press **CLR** to move to the next function without changing the date.

7.9.19 MDue

This function shows the date the instrument is due for calibration and allows it to be set. The meter calibration due date is regularly checked against the present date and if the calibration has expired the user is alerted with the message "Mtr cal expired". The message disappears only when the instrument is recalibrated and the meter calibration due date is set to a future date. To set the meter calibration due date, use the **Up** and **Down** buttons to set each date segment and the **ENT** button to move to the next date segment to the right. Press **ENT** when the date is correctly entered. Press **CLR** to move to the next function without changing the date.

7.9.20 CAL1 and CAL2

The CAL1 and CAL2 calibration parameters calibrate the instrument's PRT range and thermistor range respectively. These parameters directly affect the accuracy of the instrument and are only to be altered by an authorized, qualified technician as part of a regular instrument calibration operation. If the instrument is ever reinitialized, these parameters are reset to 0. Refer to the calibration procedure in Section 9. Use the **Up** and **Down** buttons to set the value and press the **ENT** button to store and continue. Press **CLR** to move to the next function without changing the date.

8 Communications Interface

Remote communications allows an external device, such as a computer, to communicate with the instrument to obtain measurement data and control its operation. Communication is accomplished with various commands issued to the instrument through the RS-232 serial port.

8.1 RS-232 Connection

The three-conductor jack for the serial port is located on the top of the instrument near the probe connector. One serial cable is included with the instrument. Additional or longer cables, of three meters or less, can be constructed by following the wiring diagram shown in Figure 8.



NOTE: The TxD line on one side connects to the RxD line on the other and vice-versa.

To reduce the possibility of electrical interference, the serial cable should be shielded with low resistance between the connector and the shield. It should not be much longer than is necessary.

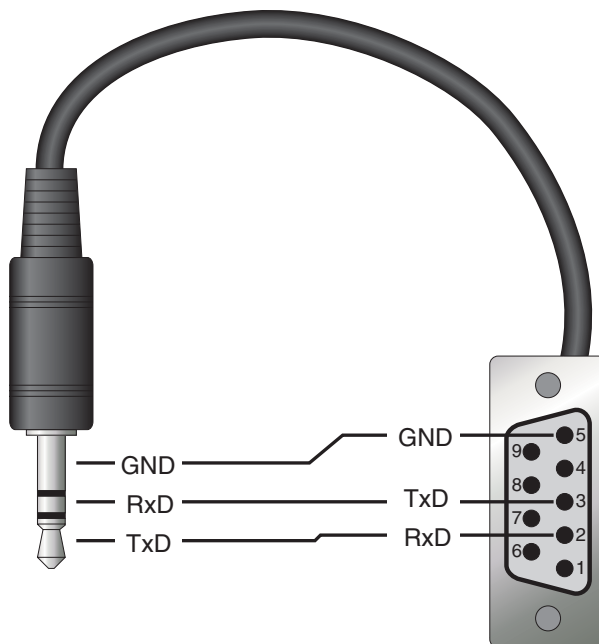

Figure 8 RS-232 Wiring

The protocol for serial communications is 8 data bits, 1 stop bit, and no parity. **Use no flow control.** The baud rate is fixed at 2400, the linefeed to ON (all carriage returns are followed by a linefeed (ASCII decimal 10)), and the duplex to HALF disabling echo.

The serial port can be used to transmit measurements to a computer or printer. It can also be used to change settings of the instrument from a computer or interface with software. A full list of commands follows in Section 8.2.





Commands sent to the instrument must end with an EOS character which is a carriage return (ASCII decimal 13) or linefeed character (ASCII decimal 10). Commands can be sent with upper or lower case letters. Data returned from the instrument ends with a carriage return and a linefeed.

8.2 Communication Command List

8.2.1 Primary Commands

The following group of commands read or set various functions.

Description	Command	Example	Response Format	Response Example	Range
Read measurement, extended format	t[emperature]	t	t: 999.999 {C, O, F, R, or K} mm-dd-yyyy hh:mm:ss	t: 125.745 C 03-01-1999 15:49:15	
Read measurement, simple format	f[etch?] rea[d?] me[asure?]	fetch? read? meas?	t: 999.999 {C, O, F, R, or K}	t: 25.587 C	
Read minimum	m[inimum]	min	min: 999.999 {C, O, F, R, or K}	min: -14.653 C	
Read maximum	ma[ximum]	max	max: 999.999 {C, O, F, R, or K}	max: 416.781 C	
Clear minimum and maximum	cl[ear]	clear			
Read data labels Note: This command also sets the autolog label.	lbnn	lb01	lb99: xxxxxxxx	Lb01: BATH	
Set data labels	lbnn=[nnnnnnnn]	lb01=ENG			0 to 9, A to Z, -, _
Initiate download of demand logged data	ddem	ddem			
Clear demand logged data	dclr	dclr			
Read the number of demand logged readings currently in memory	dlog	dl	dl: 999	dl: 51	
Read number of readings in autolog memory	alog	alog	log:9999	log:10	

Description	Command	Example	Response Format	Response Example	Range
Set autolog mode on/off .  Note: Exit Autolog menu to use this command. After alog =ON is sent, the buttons are disabled until the command alog=OFF is sent.	alog=[ON/OFF]	alog=ON			ON or OFF
Clear autolog memory	aclr	aclr			
Initiate download of autologged data.  Note: Read Section 11.2 on downloading autologged data before attempting to use this command.	daut	daut			
Read autolog interval	aint	aint	int: 99 {secs or min}	int: 60 {secs or min}	
Set autolog interval  Note: See Section 7.4.2 for specifics on log interval.	aint=n	aint=30			1, 5, 10, 10, 15, 30, 60, 120, 300, 600, 900, 1800, 3600
Read delta(x) measurement	dx	dx	dx: 999.999 {C, O, F, R, or K}	dx: -0.118 C	
Set delta(x) reference to present measurement	sd[x]	sd			
Read unit	u[nit]	u	u: {C, O, F, R, or K}	u: C	
Set unit	u[nit]=C/O/F/K/R	u=C			C, O, F, K, R
Read serial sample rate	sa[mple]	sa	sa: 99999	sa: 10	
Set serial sample rate	sa[mple]=n	sa=60			0 to 10,000
Read resolution digits	re[resolution]	res	res: 9	res: 3	
Set resolution digits	re[resolution]=n	res=0			1 to 3
Read time	ti[me]	time	ti: hh:mm:ss	ti: 16:23:45	
Set time  Note: You must set hours, minutes, and seconds for the time to be set correctly.	ti[me]=hh:mm:ss	ti=08:15:00			00:00:00 to 23:59:59
Read identification information	*i[dn?]	*idn?	<manufacturer>, <model>, <serial number>, <firmware version>	Hart, 1522, 95001, 1.24	
Read model and firmware version	*v[ersion]	*ver	ver.<model>, <firmware version>	ver.1522, 1.24	
Legend:	[] Optional Command data	{ } Returns either information			

Description	Command	Example	Response Format	Response Example	Range
	n	Numeric data supplied by user			
	9	Numeric data returned to user			
	x	Character data returned to user			

8.2.2 Calibration Commands

The following group of commands directly or indirectly affect the accuracy of the instrument. These commands should only be used by qualified, authorized personnel. **Calibration parameters can only be changed if protection is disabled by entering the proper pass-code using the command *pas= ddddd.** Entering an invalid passcode or cycling the power re-establishes protection of the calibration parameters. The parameters can be read without disabling passcode protection.

Description	Command	Example	Response Format	Response Example	Range
Unprotect calibration parameters with the pass-code	*pas[scode]=nnnnn	*pas=12345			
Read passcode protection state	*pas	*pas	ps: 9	Ps: 0	0 or 1
Read date	da[te]	date	da: yyyy-mm-dd	da: 1999-03-28	
Set date	da[te]=yyyy-mm-dd	da=1999-03-28			1999-01-01 to 2100-12-31
Read probe serial number	se[rial]	ser	ser: xxxxxxxxxx	ser: 100231A	
Set probe serial number	se[rial]=xxxxxxxxx	ser=001			0 to 9, A to Z, , -, /
Read probe type	p[robe]	pr	pr: {ITS-90, IEC751, CVD, YSI400, THERM}	pr: ITS-90	
Set probe type	p[robe]=IT[S-90]/IE[C751]/C[VD]/Y[SI400]/T[HR]	pr			ITS-90, IEC751, CVD, YSI400, THERM
Read ITS-90 R(.01) or CVD R0	r[0]	r0	r0: 999.999	r0: 100.035	
Set ITS-90 R(.01) or CVD R0	r[0]=n	r0=100.106			1 to 900
Read ITS-90 coefficient	a/b/c/d/a4/b4	a	{a/b/c/d/a4/b4}: -9.999999E-99	a: -2.8644101E-05	
Set ITS-90 coefficient	a/b/c/d/a4/b4=n	a=-2.8644E-5			1.0 to 9.9e-18
Read CVD coefficient	al[pha]/de[ltta]/be[ta]	al	{al/de/be}: 9.99999999	al: 0.00385762	
Set CVD coefficient	al[pha]/de[ltta]/be[ta]=n	al=0.0038512			Coefficient Dependent
Read THERM thermistor coefficient	b0/b1/b2/b3	b3	{b0/b1/b2/b3}: 9.999999E-99	b3: -9.944070E-12	
Set THERM thermistor coefficient	b0/b1/b2/b3=n	b3=-9.944E-12			E+/-18

Description	Command	Example	Response Format	Response Example	Range
Read probe wires	w[ires]	wi	wi: 9	wi: 4	
Set probe wires	w[ires]=2/3/4	wi=4			2,3,4
Read probe calibration date	pc[al]	pcal	pc: yyyy-mm-dd	pc: 1999-03-28	
Set probe calibration date	pc[al]=yyyy-mm-dd	pc=1999-03-28			1971-01-01 to 2099-12-31
Read probe due date	pd[ue]	pdue	pd: yyyy-mm-dd	pd: 1999-03-28	
Set probe due date	pd[ue]=yyyy-mm-dd	pd=1999-03-28			1971-01-01 to 2099-12-31
Read filter	fi[lter]	fi	fi: 99.999999	fi: 0.5	
Set filter	fi[lter]=n	fi=0			0.0 to 60.0
Read low range calibration	*c1	*c1	*c1: 9.999	*c1: -0.0121	
Set low range calibration	*c1=n	*c1=-0.012			-1.999 to 1.999
Read high range calibration	*c2	*c2	*c2: 9999.9	*c2: -0.9	
Set high range calibration	*c2=n	*c2=-0.9			-1980.0 to 1980.0
Read meter calibration date	mc[al]	mcal	mc: yyyy-mm-dd	mc: 1999-03-28	
Set meter calibration date	mc[al]=yyyy-mm-dd	mc=1999-03-28			1971-01-01 to 2099-12-31
Read meter due date	md[ue]	mdue	md: yyyy-mm-dd	md: 1999-03-28	
Set meter due date	md[ue]=yyyy-mm-dd	md=1999-03-28			1971-01-01 to 2099-12-31
Legend:	[] Optional Command data {} Returns either information n Numeric data supplied by user 9 Numeric data returned to user x Character data returned to user				

9 Calibration

The 1522 should be calibrated at regular intervals to ensure that it continues to measure with proper accuracy. Calibration should only be done by qualified, authorized personnel.

9.1 Required Equipment

The following items are required to test and calibrate the 1522:

- 0 Ω four-wire resistor (short)
- 25 Ω four-wire resistor, uncertainty within 20 ppm ($\pm 0.0005\Omega$)
- 100 Ω four-wire resistor, uncertainty within 20 ppm ($\pm 0.002\Omega$)
- 400 Ω four-wire resistor, uncertainty within 20 ppm ($\pm 0.008\Omega$)
- 4 k Ω four-wire resistor, uncertainty within 50 ppm ($\pm 0.2\Omega$)
- 10 k Ω four-wire resistor, uncertainty within 50 ppm ($\pm 0.5\Omega$)
- 40 k Ω four-wire resistor, uncertainty within 50 ppm ($\pm 2\Omega$)
- 100 k Ω four-wire resistor, uncertainty within 50 ppm ($\pm 5\Omega$)
- 500 k Ω four-wire resistor, uncertainty within 75 ppm ($\pm 37.5\Omega$)

Each resistor must be attached with an INFO-CON probe connector. The 25 Ω , 100 Ω , and 400 Ω resistors must be programmed with the CVD probe type with units set to ohms. The 4 k Ω , 10 k Ω , 40 k Ω , 100 k Ω , and 500 k Ω resistors must be programmed with the THERM probe type with units set to ohms.

9.2 Calibration Procedure

Calibration requires adjustment of the CAL1 and CAL2 parameters at 100 Ω and 10 k Ω respectively (see Section 7.9.20). The calibration parameters can be accessed from the front panel by pressing the **MODE** button and holding it for three seconds, releasing it, then pressing the **ENT** button (see Section 7.9). You must enter the pass-code to continue (see Section 7.9.4). The step-by-step procedure is as follows:

1. Connect the 100 Ω resistor. Adjust the CAL1 parameter by subtracting the measured error. For example, if the resistor is exactly 100.000 Ω and the 1522 measures 100.029 Ω , CAL1 should be adjusted by subtracting 0.029 from the current value of CAL1.
2. Verify the accuracy at 0 Ω , 25 Ω , 100 Ω , and 400 Ω .
3. Connect the 10 k Ω resistor. Adjust the CAL2 parameter by subtracting the measured error. For example, if the resistor is exactly 10.0000 k Ω and the 1522 measures 10.0029 k Ω , CAL2 should be adjusted by subtracting 2.9 from the current value of CAL2.

4. Verify the accuracy at 0Ω , $4k\Omega$, $10 k\Omega$, $40 k\Omega$, $100 k\Omega$, and $500 k\Omega$.
5. Set the meter calibration date to the present date (see Section 7.9.18).
6. Set the meter due date to a user defined date (see Section 7.9.19).

10 Maintenance

- This instrument has been designed with the utmost care. Ease of operation and simplicity of maintenance have been a central theme in the product development. With proper care the instrument should require very little maintenance. Avoid operating the instrument in oily, wet, dirty, or dusty environments.
- If the outside of the instrument becomes soiled, it may be wiped clean with a damp cloth and mild detergent. Do not use harsh chemicals on the surface which may damage the LCD or the plastic outside shell.
- If a hazardous material is spilt on or inside the equipment, the user is responsible for taking the appropriate decontamination steps as outlined by the national safety council with respect to the material.
- Before using any cleaning or decontamination method except those recommended by Hart, users should check with an Authorized Service Center (see Section 1.3) to be sure that the proposed method will not damage the equipment.
- If the AC adapter becomes damaged, have it replaced immediately. Never disassemble the AC adapter or attempt to repair it.
- If the instrument is used in a manner not in accordance with the equipment design, the operation of the thermometer readout may be impaired or safety hazards may arise.

11 Troubleshooting

In case you run into difficulty while operating the 1522, this section provides some suggestions that may help you solve the problem. Below are several situations that may arise followed by possible causes of the problem and suggested actions you might take.

11.1 An Error Message Is Displayed

The following table lists possible error messages, their causes, and suggested actions.

Problem	Solution
"Recharge Needed"	The battery is low and needs to be recharged. When this message first appears the user has approximately 30 minutes of charge left. If the battery is not recharged, the 1522 continues to operate until the battery drops below 0% and then automatically shuts itself off after displaying the error message.
"-----"	The display shows '-----'. The instrument is unable to detect that a probe is connected. Check that a probe with a properly programmed INFO-CON connector is attached.
"Probe is locked"	The incorrect probe is attached. The meter is set to accept only the probe with the given serial number. Attach the correct probe or have the instrument properly programmed for the new probe. See Section 7.9.6, Probe Lock.
"Prb cal expired"	The probe calibration has expired. Have the probe calibrated and the calibration due date reset.
"Mtr cal expired"	The meter calibration has expired. Have the instrument calibrated and the calibration due date reset.
"Invalid Passcode"	The passcode entered was not correct. Check the passcode on the Passcode Notice sent with the instrument.
The instrument display is blank when normally it should show measurements.	Make sure the instrument has power, either from the batteries or the AC adapter. Verify that the initialization information appears on the display when the power is switched on. Check to make sure that a probe is properly connected. Check to make sure that the INFO-CON connector is programmed properly.
"Uploading params"	Probe parameters have been edited. The probe parameters were edited in the CAL Mode and either the MODE button was pressed while in the CAL Mode or the MODE button was pressed after scrolling through the CAL mode and leaving the PDue parameters. After the parameters have been uploaded into the INFO-CON probe connector, the meter advances to the next display mode or to the next function in the CAL Mode.

Problem	Solution
While attempting to measure resistance the display shows an incorrect value.	<p>Poor or incorrect connection of the probe. A common mistake is to connect the wires of the probe to the wrong terminals. Check the wiring carefully (see Figure 6).</p> <p>Open, shorted, or damaged sensor or lead wires. Check the resistance across the sensor using a handheld DMM. Also check the resistance between common pairs of leads. Check to make sure there is no conductivity between any of the leads and the probe sheath. Use a good-quality sensor to avoid errors caused by drift, hysteresis, or insulation leakage.</p> <p>Stem conduction error. Make sure the stem of the probe is immersed in the medium with adequate depth and a tight fit.</p> <p>Electrical interference. Intense radio-frequency radiation near the 1522 or the probe can induce noise into the measurement circuits resulting in erratic readings. Try eliminating the source of interference or moving the 1522 to a different location. A well-grounded, shielded cable should be used for the probe.</p>
Memory Check Error	<p>Memory Recover X. A critical parameter (CAL1, CAL2, or Passcode) is corrupt and the instrument can recover the correct value for that parameter. Press any key and the display reads "Check Settings". Press any key again to resume normal operation. Also, check other settings in the thermometer (if used), such as, filter, units, and resolution. The number following the message is used by authorized technicians.</p> <p>Memory Invalid! A critical parameter (CAL1, CAL2, Passcode, Meter Due Date, Meter Cal Date, or Serial Number) is corrupt and the instrument cannot recover the correct value for that parameter. Press any key and the display reads "Contact Factory". Contact a Hart Authorized Service Center (see Section 1.3) for assistance in guiding you through the process of reentering these parameters.</p> <p>Note: The parameters stored in the INFO-CON, Probe Wires, Probe Type, Probe Parameters, are not checked by the meter during memory testing.</p>

11.2 Downloading Autologged Data

The 1522 Handheld Thermometer readout stores up to 10,000 readings in its autolog memory. These readings can be downloaded to a computer using the RS-232 serial port. By default, the 1522 serial port operates at 2400 baud. However, when downloading autologged readings over the serial port or printing to a serial printer, the instrument temporarily changes its baud rate to 9600 baud to reduce the download time.

The following steps should be followed to download autologged data using the serial port:

1. Connect the instrument to a COM port on the computer using the serial cable.
2. Run a terminal program such as Windows® Terminal or HyperTerminal®.

- a) Set up the terminal program to use the correct COM port and operate at 2400 baud, 8 data bits, 1 stop bit, no parity, no flow control.
 - b) If you want to save the downloaded data to a file, configure your terminal program to capture the incoming text and save it to a text file. Refer to your terminal program's documentation for details on how to do this.
3. To determine how many autologged readings are stored in the instrument's memory, send the command "ALOG". If the response to the "ALOG" command is "0", there are no readings to download.
 4. To begin downloading the autologged data, send the command "DAUT" to initiate the download process. The 1522 then sends a response to the terminal program indicating that the baud rate needs to be set to 9600. The 1522 automatically switches its baud rate to 9600 baud and waits to receive this same command again at 9600 baud.
 - a) In the terminal program, change the baud rate setting to 9600 baud. The terminal program connection may need to be disconnected and reconnected to enable the baud rate.
 - b) Send the command "DAUT" once again at the new baud rate. The 1522 should immediately begin downloading the data at 9600 baud. If no readings have been stored, the 1522 will not respond to "DAUT" command.
 - c) When downloading is complete, the 1522 automatically sets its baud rate back to 2400 baud.
 - d) If the terminal program was set to capture the incoming data to a file, stop capturing at this time.
 - e) In the terminal program, change the baud rate setting back to 2400 baud.
 - f) If you wish to abort the download process before it has completed, press 'CLR' on the front panel of the 1522. The 1522 sets its baud rate back to 2400 baud automatically. Reset the terminal program's baud rate to 2400 baud.
 5. If the response to the "ALOG" command was not "0" and the 1522 does not respond to the "DAUT" command, turn the 1522 off, then back on again and repeat steps 3-4.

11.3 CE Comments

11.3.1 EMC Directive

Hart Scientific's equipment has been tested to meet the European Electromagnetic Compatibility Directive (EMC Directive, 89/336/EEC). The Declaration of Conformity for your instrument lists the specific standards to which the unit was tested.

The instrument was designed specifically as a test and measuring device. Compliance to the EMC directive is through IEC 61326-1 *Electrical equipment for measurement, control and laboratory use – EMC requirements (1998)*.

As noted in the IEC 61326-1, the instrument can have varying configurations. The instrument was tested in a typical configuration with shielded, grounded probe and RS-232 cables. Emissions may, in non-typical applications, exceed the levels required by the standard. It is not practical to test all configurations, as the manufacturer has no control over the probes the user may connect to the instrument.

11.3.1.1 Immunity Testing

The instrument was tested to the requirements for industrial locations. This allows the instrument to be used in all types of locations from the laboratory to the factory floor. Criterion B was used for Radiated RF (IEC 61000-4-3) and Conducted RF (IEC 61000-4-6). Therefore, the operation of the instrument may be affected by excessive electromagnetic interference and the instrument may not perform within the normal specification limits in such an environment. Criterion C was used for Electrostatic Discharge (ESD, IEC 61000-4-2) and Electric Fast Transit (EFT, Burst, IEC 61000-4-4). If the instrument is subjected to EFT conditions at 2kV, the instrument may require the user to cycle the power to return to normal operation.

11.3.1.2 Emission Testing

The instrument fulfills the limit requirements for Class A equipment but does not fulfill the limit requirements for Class B equipment. The instrument was not designed to be used in domestic establishments.

11.3.2 Low Voltage Directive (Safety)

In order to comply with the European Low Voltage Directive (73/23/EEC), Hart Scientific equipment has been designed to meet the IEC 1010-1 (EN 61010-1) and the IEC 1010-2-010 (EN 61010-2-010) standards.