

FLUKE®

Hart Scientific®

2200
*Temperature Controller
User's Guide*

Limited Warranty & Limitation of Liability

Each product from Fluke Corporation, Hart Scientific Division ("Hart") is warranted to be free from defects in material and workmanship under normal use and service. The warranty period is 2 years for the Temperature Controller. The warranty period begins on the date of the shipment. Parts, product repairs, and services are warranted for 90 days. The warranty extends only to the original buyer or end-user customer of a Hart authorized reseller, and does not apply to fuses, disposable batteries or to any other product, which in Hart's opinion, has been misused, altered, neglected, or damaged by accident or abnormal conditions of operation or handling. Hart warrants that software will operate substantially in accordance with its functional specifications for 90 days and that it has been properly recorded on non-defective media. Hart does not warrant that software will be error free or operate without interruption. Hart does not warrant calibrations on the Temperature Controller.

Hart authorized resellers shall extend this warranty on new and unused products to end-user customers only but have no authority to extend a greater or different warranty on behalf of Hart. Warranty support is available if product is purchased through a Hart authorized sales outlet or Buyer has paid the applicable international price. Hart reserves the right to invoice Buyer for importation costs of repairs/replacement parts when product purchased in one country is submitted for repair in another country.

Hart's warranty obligation is limited, at Hart's option, to refund of the purchase price, free of charge repair, or replacement of a defective product which is returned to a Hart authorized service center within the warranty period.

To obtain warranty service, contact your nearest Hart authorized service center or send the product, with a description of the difficulty, postage, and insurance prepaid (FOB Destination), to the nearest Hart authorized service center. Hart assumes no risk for damage in transit. Following warranty repair, the product will be returned to Buyer, transportation prepaid (FOB Destination). If Hart determines that the failure was caused by misuse, alteration, accident or abnormal condition or operation or handling, Hart will provide an estimate or repair costs and obtain authorization before commencing the work. Following repair, the product will be returned to the Buyer transportation prepaid and the Buyer will be billed for the repair and return transportation charges (FOB Shipping Point).

THIS WARRANTY IS BUYER'S SOLE AND EXCLUSIVE REMEDY AND IS IN LIEU OF ALL OTHER WARRANTIES, EXPRESS OR IMPLIED, INCLUDING BUT NOT LIMITED TO ANY IMPLIED WARRANTY OF MERCHANTABILITY OR FITNESS FOR A PARTICULAR PURPOSE. HART SHALL NOT BE LIABLE FOR ANY SPECIAL, INDIRECT, INCIDENTAL, OR CONSEQUENTIAL DAMAGES OR LOSSES, INCLUDING LOSS OF DATA, WHETHER ARISING FROM BREACH OF WARRANTY OR BASED ON CONTRACT, TORT, RELIANCE OR ANY OTHER THEORY.

Since some countries or states do not allow limitation of the term of an implied warranty, or exclusion or limitation of incidental or consequential damages, the limitations and exclusions of this warranty may not apply to every buyer. If any provision of this Warranty is held invalid or unenforceable by a court of competent jurisdiction, such holding will not affect the validity or enforceability of any other provision.

Fluke Corporation, Hart Scientific Division

799 E. Utah Valley Drive • American Fork, UT 84003-9775 • USA
Phone: +1.801.763.1600 • Telefax: +1.801.763.1010
E-mail: support@hartscientific.com

www.hartscientific.com

Subject to change without notice. • Copyright © 2005 • Printed in USA

Table of Contents

1	Before You Start	1
1.1	Introduction	1
1.2	Symbols Used	1
1.3	Safety Information	2
1.3.1	WARNINGS	2
1.3.2	CAUTIONS	4
1.4	Authorized Service Centers	5
2	Specifications and Environmental Conditions	9
2.1	Specifications	9
2.2	Environmental Conditions	9
3	Quick Start	11
3.1	Unpacking	11
3.2	Set Up	11
3.3	Setting the Temperature	11
4	Installation	13
4.1	Setup	13
4.2	Heater	13
4.3	Control Probe	13
4.4	Power	14
4.5	Fuses	15
5	Parts and Controls	17
5.1	Front Panel	17
5.2	Back Panel	18
6	General Operation	21
6.1	Control System	21
6.2	Temperature Controller	21
7	Controller Operation	23
7.1	Process temperature	23
7.2	Temperature Set-point	23
7.2.1	Programmable Set-points	23

7.2.2	Set-point Value	25
7.3	Temperature Scale Units	25
7.4	Scan	26
7.4.1	Scan Control	26
7.4.2	Scan Rate	27
7.5	Set-point Resistance	27
7.6	Secondary Menu.	27
7.7	Heater Power	27
7.8	Proportional Band	28
7.9	Controller Configuration	29
7.10	Calibration Parameters	30
7.10.1	R0	30
7.10.2	ALPHA	30
7.10.3	DELTA	30
7.10.4	BETA	30
7.10.5	Integral time adjustment	31
7.11	Operating Parameters	31
7.11.1	HL and LL	31
7.11.2	DP (Decimal Place).	32
7.12	Serial Interface Parameters	32
7.12.1	Baud Rate	33
7.12.2	Sample Period.	33
7.12.3	Duplex Mode	33
7.12.4	Linefeed.	34
8	Digital Communication Interface	35
8.1	Serial Communications	35
8.1.1	Wiring.	35
8.1.2	Setup	35
8.1.2.1	Baud Rate.	36
8.1.2.2	Sample Period.	36
8.1.2.3	Duplex Mode	36
8.1.2.4	Linefeed.	36
8.1.3	Serial Operation.	36
8.2	Interface Commands	37
9	Calibration Procedure	41
9.1	Single Point Calibration	41
9.2	Three Point Calibration Procedure	41
9.2.1	Compute DELTA:	41
9.2.2	Compute R & ALPHA:	42
9.2.3	Accuracy & Repeatability.	43
10	Troubleshooting.	45

10.1	Troubleshooting Problems, Possible Causes, and Solutions	45
10.2	CE Comments	46
10.2.1	EMC Directive	46
10.2.2	Low Voltage Directive (Safety)	46

Figures and Tables

- Table 1 International Electrical Symbols 1
- Figure 1 Controller to Heater Wiring 13
- Figure 2 RTD Probe Wiring 14
- Figure 3 Front Panel 17
- Figure 4 Back Panel 18
- Figure 5 Controller Operation Flowchart 24
- Figure 6 Various Proportional Band Settings 28
- Figure 7 Serial Cable Wiring 35
- Table 2 Interface Commands 38
- Table 2 Interface Commands continued 39

1 Before You Start

1.1 Introduction

Fluke's Hart Scientific Division's 2200 Temperature Controller is a solid state temperature controller. A unique combination of analog and digital electronic circuitry provides exceptional accuracy and stability together with ease of operation and programmability.

Temperature sensing is done with a 2-wire 100 ohm platinum resistance probe which plugs into the back of the controller. To maintain a constant temperature the power to the heater is pulse width modulated by means of a solid-state relay. The maximum current rating of the controller is 10 amps.







The 2200 controller can be easily programmed via the four-button front panel or by the serial interface. Programming allows the user to set the control temperature, units °C or °F, and the calibration variables. The process or actual temperature is continuously displayed on an LED panel. The percent heating power may also be monitored.











Before using the 2200 controller, you should understand the proper setup and operation.

1.2 Symbols Used

Table 1 lists the International Electrical Symbols. Some or all of these symbols may be used on the instrument or in this manual.

Table 1 International Electrical Symbols

Symbol	Description
	AC (Alternating Current)
	AC-DC
	Battery
	CE Complies with European Union Directives
	DC
	Double Insulated

Symbol	Description
	Electric Shock
	Fuse
	PE Ground
	Hot Surface (Burn Hazard)
	Read the User's Manual (Important Information)
	Off
	On
	Canadian Standards Association
CAT II	OVERVOLTAGE (Installation) CATEGORY II, Pollution Degree 2 per IEC1010-1 refers to the level of Impulse Withstand Voltage protection provided. Equipment of OVERVOLTAGE CATEGORY II is energy-consuming equipment to be supplied from the fixed installation. Examples include household, office, and laboratory appliances.
	C-TIC Australian EMC Mark
	The European Waste Electrical and Electronic Equipment (WEEE) Directive (2002/96/EC) mark.

1.3 Safety Information

Use this instrument only as specified in this manual. Otherwise, the protection provided by the instrument may be impaired.

The following definitions apply to the terms “Warning” and “Caution”.

- “Warning” identifies conditions and actions that may pose hazards to the user.
- “Caution” identifies conditions and actions that may damage the instrument being used.

1.3.1 WARNINGS

To avoid personal injury, follow these guidelines.

GENERAL

The instrument does not come with a system cutout or cutout capability. The user should provide a bi-metal cutout or other safety device for the system.

DO NOT use the instrument for any application other than calibration work. The instrument was designed for temperature calibration. Any other use of the instrument may cause unknown hazards to the user.

DO NOT use the instrument in environments other than those listed in the user's guide.

Follow all safety guidelines listed in the user's manual.

Calibration Equipment should only be used by Trained Personnel.

If this instrument is used in a manner not specified by the manufacturer, the protection provided by the instrument may be impaired.

If the instrument is used to control a calibration heat source, be sure that the heater is wired correctly (see Figure 1 on page 13).

Before initial use, or after transport, or after storage in humid or semi-humid environments, or anytime the dry-well has not been energized for more than 10 days, the instrument needs to be energized for a "dry-out" period of 2 hours before it can be assumed to meet all of the safety requirements of the IEC-61010-1. If the product is wet or has been in a wet environment, take necessary measures to remove moisture prior to applying power such as storage in a low humidity temperature chamber operating at 50°C for 4 hours or more.

The instrument is intended for indoor use only.

The instrument is a precision instrument. Although it has been designed for optimum durability and trouble free operation, it must be handled with care.

Operate the instrument in room temperatures listed in Section 2.2, Environmental Conditions. The instrument is not vented. Therefore, clearance for ventilation is not a requirement. However, do not place the instrument on top of a calibration bath or dry-well where it would be in contact or direct path of heat.

DO NOT stack items on top of the instrument.

BURN HAZARD

The instrument can be used to control instruments which generate extreme temperatures. Precautions must be taken to prevent personal injury or damage to objects. Probes may be extremely hot or cold when removed from a calibration bath. Cautiously handle probes to prevent personal injury. Carefully place probes on a heat resistant surface or rack until they are at room temperature. Fires and severe burns may result if personnel fail to observe safety precautions.

ELECTRICAL HAZARD

These guidelines must be followed to ensure that the safety mechanisms in this instrument will operate properly. The instrument must be plugged into an appropriate outlet as specified in Section 2.1, Specifications, on page 9. Also, the current and voltage capability of the instrument must not be exceeded. The power cord of the instrument is equipped with a three-pronged grounding plug for your protection against electrical shock hazards. It must be plugged directly into a properly grounded three-prong receptacle. The receptacle must be installed in accordance with local codes and ordinances. Consult a qualified electrician. **DO NOT** use an extension cord or adapter plug.

DO use a ground fault interrupt device. This system that is controlled by this instrument may contain a fluid. A ground fault device is advised in case fluid is present in the electrical system and could cause an electrical shock.

Always replace the power cord with an approved cord of the correct rating and type. If you have questions, contact a Authorized Service Center (see Section 1.4).

High voltage is used in the operation of this equipment. Severe injury or death may result if personnel fail to observe the safety precautions. Before working inside the instrument, turn off the power and disconnect the power cord.

FLUIDS

Fluids used in the system controlled by this instrument may produce noxious or toxic fumes under certain circumstances. Consult the fluid manufacturer's MSDS (Material Safety Data Sheet). Proper ventilation and safety precautions must be observed.

The instrument is not equipped with cutout capability. User should use a bi-metal cutout or other cutout device with the system, which will insure that the flash point, boiling point, or other key fluid characteristics are not exceeded.

1.3.2 **CAUTIONS**

To avoid possible damage to the instrument, follow these guidelines.

Do not plug the instrument into 230V if the indicator window of the power entry module reads 115V. This action will cause the fuses to blow and may damage the instrument.

DO use a ground fault interrupt device.

Operate the instrument in room temperatures as listed in Section 2.2, Environmental Conditions.

Calibration constants should only be changed by trained personnel. The correct setting of these parameters is important to the safety and proper operation of the instrument.

The Factory Reset Sequence should be performed only by authorized personnel if no other action is successful in correcting a malfunction. You must have a copy of the most recent Report of Test to restore the test parameters.

DO NOT operate this instrument in an excessively wet, oily, dusty, or dirty environment or place in locations where hot or cold liquids are splashed on it.

Most probes have handle temperature limits. Be sure that the probe handle temperature limit is not exceeded in the air above the system controlled by this instrument.

The instrument and any thermometer probes used with it are sensitive instruments that can be easily damaged. Always handle these devices with care. Do not allow them to be dropped, struck, stressed, or overheated.

DO NOT use this instrument in a system that exceeds the current capability of the instrument as listed in Section 2.1, Specifications, on page 9.

DO NOT replace fuse(s) with one of a higher current rating or type. Always replace the fuse with one of the same rating, voltage, and type. The current rating listed in Section 2.1, Specifications, on page 9 is the maximum for the instrument. If the instrument is connected to a system which uses less than the maximum capability of this instrument, the fuses need to be changed in order to be correct for the system. Once the instrument is connected to the system, the system current needs to be measured or calculated and the appropriate fuse size and characteristics selected. Section 4.5, Fuses, on page 15 can be used as a guide for selecting a fuse.

Once the correct fuse type and rating is selected, the following information is applicable. The instrument is equipped with operator accessible fuses. If a fuse blows, it may be due to a power surge or failure of a component. Replace the fuses once. If a fuse blows a second time, it is likely caused by failure of a component. As a test disconnect the output device (heater) and apply power to the rest of the system. Check to see if the fuse(s) blow. If the fuse(s) blow only when the output device (heater) is connected, the fault may be in the heater. If not, contact an Authorized Service Center (see Section 1.4).

If a mains supply power fluctuation occurs, immediately turn off the instrument. Power bumps from brown-outs and black-outs can damage the system. Wait until the power has stabilized before re-energizing the instrument.

For best accuracy, the instrument needs to be calibrated with the system it controls.

1.4 Authorized Service Centers

Please contact one of the following authorized Service Centers to coordinate service on your Hart product:

Fluke Corporation, Hart Scientific Division

799 E. Utah Valley Drive

American Fork, UT 84003-9775
USA

Phone: +1.801.763.1600
Telefax: +1.801.763.1010
E-mail: support@hartscientific.com

Fluke Nederland B.V.

Customer Support Services
Science Park Eindhoven 5108
5692 EC Son
NETHERLANDS

Phone: +31-402-675300
Telefax: +31-402-675321
E-mail: ServiceDesk@fluke.nl

Fluke Int'l Corporation

Service Center - Instrimpex
Room 2301 Sciteck Tower
22 Jianguomenwai Dajie
Chao Yang District
Beijing 100004, PRC
CHINA

Phone: +86-10-6-512-3436
Telefax: +86-10-6-512-3437
E-mail: xingye.han@fluke.com.cn

Fluke South East Asia Pte Ltd.

Fluke ASEAN Regional Office
Service Center
60 Alexandra Terrace #03-16
The Comtech (Lobby D)
118502
SINGAPORE

Phone: +65 6799-5588

Telefax: +65 6799-5588

E-mail: antng@singa.fluke.com

When contacting these Service Centers for support, please have the following information available:

- Model Number
- Serial Number
- Voltage
- Complete description of the problem

2 Specifications and Environmental Conditions

2.1 Specifications

Temperature Range	-100°C to 800°C (-73°F to 1472°F)
Accuracy	±1.0°C without system calibration
Stability	±0.015 (depending on application)
Stabilization Time	approximately 30 minutes (depends on system design)
Control Probe	100Ω RTD
Resolution	0.01°C/°F
Readout	Switchable °C or °F
Controller	Digital controller with data retention
Fault Protection	Sensor burnout and short protection
Heater Output (max)	115 VAC (±10%), 50/60 Hz, 7.8 A, 895 W 230 VAC (±10%), 50/60 Hz, 7.8 A, 1790 W
Power (max)	115 VAC (±10%), 50/60 Hz, 8 A, 920 W 230 VAC (±10%), 50/60 Hz, 8 A, 1840 W  NOTE: Internal electronics require 0.2 A to operate.
System Fuses	10 A 250 V fast acting (max)
Exterior Dimension	7.2 cm H x 11.4 cm W x 17.8 cm D (2.85 x 4.5 x 7 in)
Weight	0.9 kg (2 lbs.)
Safety	OVERVOLTAGE (Installation) CATEGORY II, Pollution Degree 2 per IEC-61010-1

2.2 Environmental Conditions

Although the instrument has been designed for optimum durability and trouble-free operation, it must be handled with care. The instrument should not be operated in an excessively dusty or dirty environment. Maintenance and cleaning recommendations can be found in the Maintenance Section of this manual.

The instrument operates safely under the following conditions:

- temperature range: 5 - 50°C (41 - 122°F)
- ambient relative humidity: maximum 80% for temperature <31°C, decreasing linearly to 50% at 40°C
- pressure: 75kPa - 106kPa
- mains voltage within ± 10% of nominal
- vibrations in the calibration environment should be minimized

- altitude does not effect the performance or safety of the unit
- indoor use only

3 Quick Start

This chapter gives a brief summary of the steps required to set up and operate the 2200 temperature controller. This should be used as a general overview and reference and not as a substitute for the remainder of the manual. Please read Sections 4 through 6 carefully before operating the controller.

3.1 Unpacking

Unpack the controller carefully and inspect it for any damage that may have occurred during shipment. If there is shipping damage, notify the carrier immediately.

An RTD control probe should have been purchased along with the controller. Typically, the user provides the bath or system to be controlled and the heater.

Verify that the following components are present:

- 2200 Controller
- Control Probe (if ordered)
- Power Cord
- Power Cord - for the Heater
- Users Guide

3.2 Set Up

Set up of the controller requires unpacking and placement of the controller, connection of the heater, installation of the control probe, and connection of power.



CAUTION: Consult Section 4 for detailed instructions for proper installation of the controller. Pay particular attention to instructions for the heater, control probe, and power setup.

3.3 Setting the Temperature

In the following discussion and throughout this manual a solid box around the word SET, UP, DOWN or EXIT indicates the panel button to press while the dotted box indicates the display reading on the front panel. Explanation of the button function or display reading is written at the right.

To view or set the temperature set-point proceed as follows. The front panel LED display normally shows the actual process temperature.

24.68 C

Process temperature display

When “SET” is pressed the display will show the set-point memory that is currently being used and its value. Eight set-point memories are available.



Access set-point selection

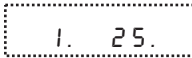

Set-point 1, 25.°C currently used

Press “SET” to select this memory and access the set-point value.



Access set-point value

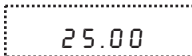

Current value of set-point 1, 25.00°C

Press “UP” or “DOWN” to change the set-point value.



Increment display

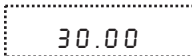

New set-point value

Press “SET” to accept the new value and access the temperature scale units. The system begins heating or cooling to the new set-point.



Store new set-point, access temperature units

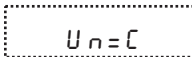

Current temperature scale units

Press “EXIT” and the process temperature will be displayed again.



Return to the temperature display

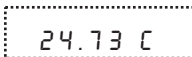

Process temperature display

The system heats or cools until it reaches the new set-point temperature.

To obtain optimum control stability adjust the proportional band as discussed in Section 7.8.

4 Installation

4.1 Setup

The 2200 controller is a precision instrument which should be located in an appropriate environment. The location should be free from excessive dirt, moisture, vibration, or temperature variations. There should be no present danger of spilled liquids.

4.2 Heater



CAUTION: Be sure that the current of the heater does not exceed the maximum capability of the instrument (see Section 2.1 on page 9).

Connect the heater to the back of the controller using the socket labeled “HEATER”. Be sure the heater cable is adequate for the amount of current required and that the heater is wired correctly and safely. See Figure 1 on page 13 for heater wiring.

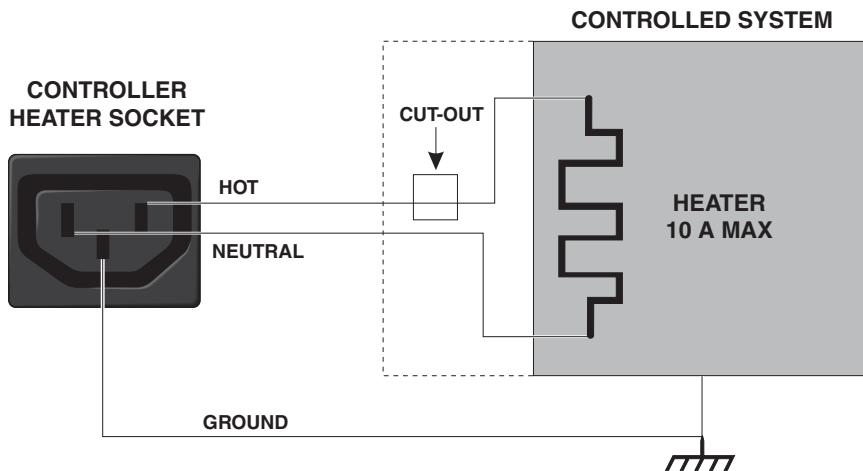

Figure 1 Controller to Heater Wiring

4.3 Control Probe

Connect the control probe into the socket at the back of the controller labeled “PROBE” (see Figure 2 on page 14). Insert the probe into the bath or system to be controlled. For best stability and response time the control probe should be

located in close proximity to the heater. Observe the maximum temperature rating of the probe and be careful it is not exceeded.

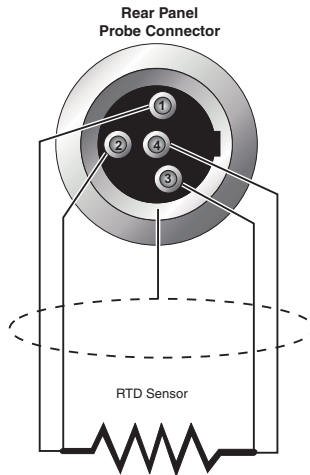

Figure 2 RTD Probe Wiring

Set the high limit (HL) less than or equal to the probe maximum temperature.

4.4 Power



CAUTION: Do not plug the instrument into 230V if the indicator window of the power entry module reads 115V. This action will cause the fuses to blow and may damage the instrument.

Plug the controller power cord into a mains outlet of the proper voltage, frequency, and current capability (see Section 2.1, Specifications on page 9). Ensure that the indicator window of the power entry module matches the voltage of the mains supply.

Turn the controller on using the rear panel "POWER" switch. The controller will turn on and begin to heat or cool the system to reach the previously programmed temperature set-point. The front panel LED display will indicate the actual process temperature. See Section 4.5, Fuses for information on selecting the correct fuse for the application.

When powered on the control panel display will briefly show a four digit number. This number indicates the number of times power has been applied to the unit. Also briefly displayed is data which indicates the controller hardware configuration. This data is used in some circumstances for diagnostic purposes.

4.5 Fuses



CAUTION: *Never use this instrument in a system that uses more power or current as listed in Section 2.1, Specifications on page 9.*

The controller is shipped from the factory with fast acting fuses rated for the maximum capacity of the instrument.

If the controller is connected to a system which uses less than 10 amps, the fuses will need to be changed in order to be correct for the system. Once the controller is connected in the system, the system current needs to be measured or calculated and the appropriate fuse size and characteristics selected. Generally, the fuse selected is rated at 125% of the maximum current of the system. The time-current characteristics of the fuse are selected by the application. Usually, fast acting fuses are selected systems without a high in-rush current, i.e. "hot" calibration baths. Time-delay or slow blow fuses are selected for systems with a high in-rush current, i.e. "cold" calibration baths. Refer to the fuseology section of your fuse catalog for help in determining fuse size and characteristics or contact an Authorized Service Center (see Section 1.4) for assistance. Once the correct fuse characteristics and rating of the fuses have been selected and the appropriate fuses placed in the power entry module of the instrument, mark the instrument so the user can visibly see the fuse size and rating for fuse replacement. Be sure to change both fuses to the new rating and correct characteristic.

The controller uses 0.2 amps of current. This current should be taken into consideration when calculating the system power.

Example when using the power of the system:

P = Power of the system (Total Watts)

V = Nominal line voltage (115 VAC or 230 VAC)

I = Fuse current

$$I = 1.25 \times \frac{P}{0.9 \times V}$$

Example when using the system current:

I = System current

I_f = Fuse current rating

$$I_f = 1.25 \times I$$

5 Parts and Controls

5.1 Front Panel

The following controls and indicators are present: (1) the digital display, (2) the control buttons. (see Figure 3)

(1) The digital display of the temperature controller displays the set and actual temperatures and various controller functions, settings, and constants. The display shows temperatures in values according to the selected scale °C or °F.

(2) The control buttons (SET, DOWN, UP, and EXIT) are used to set the temperature set-point, access and set other operating parameters, and access and set calibration parameters.

Setting the control temperature is done directly in degrees of the current scale. The control temperature can be set to ten-hundredths of a degree Celsius.

The functions of the buttons are as follows:

SET – Used to display the next parameter in the menu and to set parameters to the displayed value.

DOWN – Used to decrement the displayed value of parameters.

UP – Used to increment the displayed value.

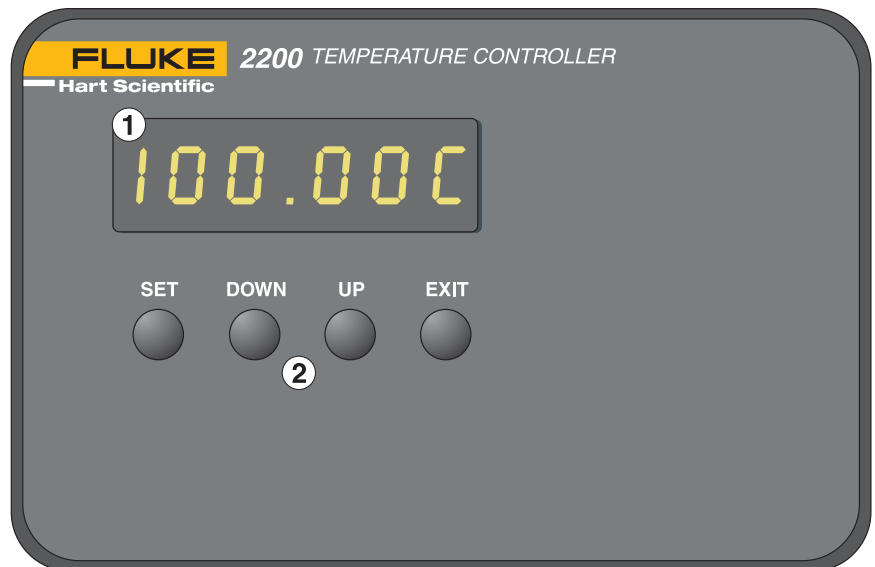

Figure 3 Front Panel

EXIT – Used to exit from a menu. When EXIT is pressed any changes made to the displayed value will be ignored.

5.2 Back Panel

The following features are found on the rear panel of the controller: (1) the power entry module, (2) the heater power connector, (3) the control probe input connector, and (4) the RS-232 interface connector (see Figure 4).

(1) The power entry module includes: (A) the IEC power line connector, (B) the ON/OFF switch, (C) the voltage selector with indicator window and two fuses. The unit is shipped from the factory with fuses as listed in the specifications (Section 2.1 on page 9). Additional information on fuse usage is in Section 4.5.

(A) The appropriate power cord with IEC connector has been included with the controller for the voltage specified in the order.

(B) The double pole single throw (DPST) power switch indicates the ON/OFF positions with the universal I/O.



WARNING: The output voltage to the heater socket (item 2 in Figure 4) is the same as the input voltage of the power entry module (item 1 in Figure 4).

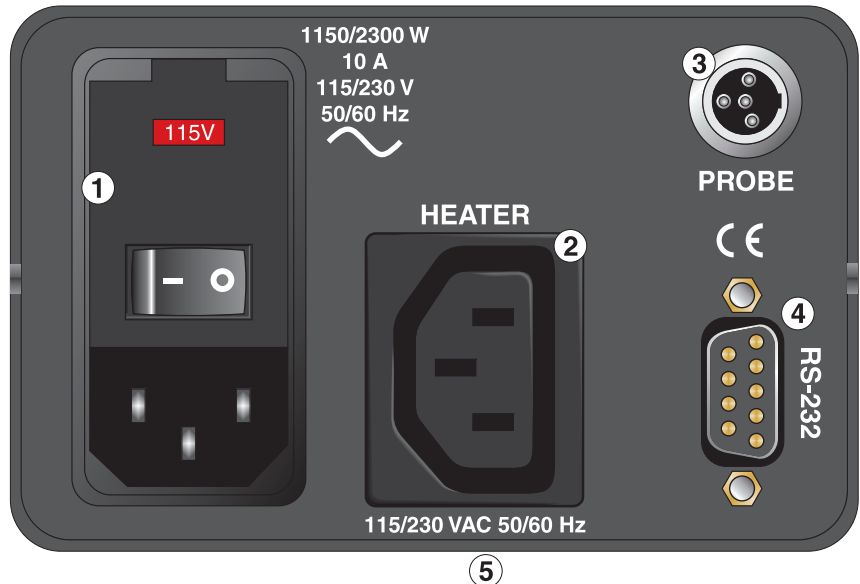

Figure 4 Back Panel

(C) The power entry module is provided with a dual voltage selector integrated into the fuse holder. The controller has been specially designed to allow either 115 or 230 VAC operation. The voltage indicator window notifies the user of the voltage selected. See [Figure 4](#).

Two fuses are contained in the internal fuse holder. The fuse holder will accept either 1/4" x 1 1/4" or 5 x 20 mm fuses. Access to the fuses and the voltage selector is obtained by placing a flathead screwdriver in the slot at the top of the power entry module and opening the module front panel.



WARNING: Access to the fuses may not be obtained with the power cord plugged into the IEC power line connector.



WARNING: The output voltage to the heater socket (item 2 in [Figure 4](#)) is the same as the input voltage of the power entry module (item 1 in [Figure 4](#)).

(2) The heater socket is the source of controlled power for the system heater. This power is switched by the solid-state relay to maintain a constant temperature. The voltage is the same as that supplied through the entry module (A). For a diagram of how to wire the heater to the controller see [Figure 1](#) on page 13. An extra line cord has been included with the unit for use with the heater socket.

(3) The control probe is plugged in here. The probe is a DIN 43760 type RTD. Probes or additional connectors for use with the user's probes are available from Hart. For assistance in wiring an RTD to the controller see [Figure 2](#) on page 14. A probe connector has been provided for use with the control probe connection.

(4) The RS-232 communications cable is connected to this 9 pin D-subminiature connector. This enables the controller to be programmed and operated remotely.

(5) The serial number label (not shown) is located on the bottom of the unit towards the back panel.

6 General Operation

6.1 Control System

The 2200 temperature controller is not specified for use with a particular system. Its flexibility enable it to be used with a large variety of control systems. Often the controller is used with a precision constant temperature bath.

It is the responsibility of the user to ensure that the components are chosen and the system constructed to ensure safe and proper operation of the complete system. The user should have a good knowledge of and experience with, electrical fundamentals and wiring practices as well as control systems. Hart Scientific cannot be responsible for any damages or injury resulting from improper design or operation of the control system. For more help or information, contact an Authorized Service Center.

6.2 Temperature Controller

The system temperature is controlled by Hart Scientific's unique hybrid digital/analog temperature controller. The controller offers the tight control stability of an analog temperature controller as well as the flexibility and programmability of a digital controller.

The temperature is monitored with a platinum resistance sensor as the control probe. The signal is electronically compared with the programmable reference signal, amplified, and then passed to a pulse-width modulator circuit which controls the amount of power applied to the heater.



WARNING: *For protection against solid-state relay failure or other circuit failure, a bi-metallic cut-out should be used.*

The controller allows the operator to set the set-point temperature with high resolution, adjust the proportional band, monitor the heater output power, and program the controller configuration and calibration parameters. The controller may be operated in temperature units of degrees Celsius or Fahrenheit. The controller is operated and programmed from the front control panel using the four key switches and digital LED display. The controller is equipped with an RS-232 serial digital interface for remote operation. Operation of the controller using the front control panel is discussed following in Section 7. Operation using the digital interface is discussed in Section 8.

When the controller is set to a new set-point the system will heat or cool to the new temperature. There may be a small overshoot or undershoot of about 0.5°C or more depending on the system and proportional band.

7 Controller Operation

This chapter discusses in detail how to operate the temperature controller using the front control panel. Using the front panel key switches and LED display the user may monitor the process temperature, set the temperature set-point in degrees C or F, monitor the heater output power, adjust the controller proportional band, and program the probe calibration parameters, operating parameters, and serial interface parameters. Operation of the functions are shown in the flowchart summarized in Figure 5.

7.1 Process temperature

The digital LED display on the front panel allows direct viewing of the process temperature. This temperature value is what is normally shown on the display. The units, C or F, of the temperature value are displayed at the right. For example,

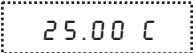
 *Process temperature in degrees Celsius*

The temperature display function may be accessed from any other function by pressing the “EXIT” button.

7.2 Temperature Set-point

The temperature can be set to any value within the range as given in the specifications with a high degree of resolution. The temperature range of the particular fluid used in a bath must be known by the operator and the bath should only be operated well below the upper temperature limit of the liquid. In addition, the high level set-point should also be set below the upper limit of the fluid.

Setting the temperature involves two steps: (1) select the set-point memory, (2) adjust the set-point value

7.2.1 Programmable Set-points

The controller stores 8 set-point temperatures in memory. The set-points can be quickly recalled to conveniently set the system to a previously programmed temperature.

To set the temperature one must first select the set-point memory. This function is accessed from the temperature display function by pressing “SET”. The number of the set-point memory currently being used is shown at the left on the display followed by the current set-point value.

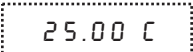
 *Process temperature in degrees Celsius*



Access set-point memory

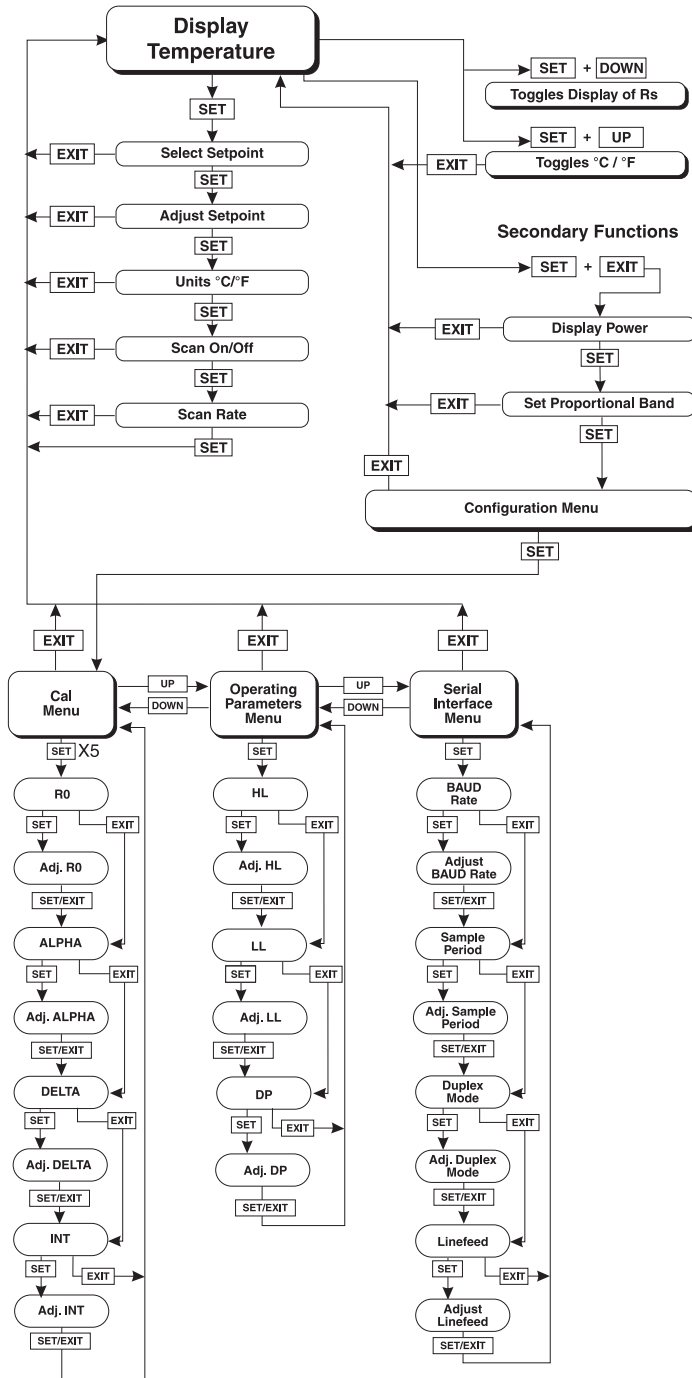
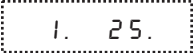



Figure 5 Controller Operation Flowchart

 *Set-point memory 1, 25.°C currently used*

To change the set-point memory press “UP” or “DOWN”.

 *Increment memory*

 *New set-point memory 4, 40.°C*

Press “SET” to accept the new selection and access the set-point value.

 *Accept selected set-point memory*

7.2.2 Set-point Value

The set-point value may be adjusted after selecting the set-point memory and pressing “SET”.

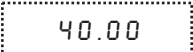
 *Set-point value*

If the set-point value need not be changed then press “EXIT” to resume displaying the probe temperature. To adjust the set-point value press “UP” or “DOWN”.

 *Increment display*

 *New set-point value*

When the desired set-point value is reached press “SET” to accept the new value and access the temperature scale units. If “EXIT” is pressed, any changes made to the set-point are ignored.

 *Accept new set-point value*

7.3 Temperature Scale Units

The temperature scale units of the controller may be set by the user to degrees Celsius (°C) or Fahrenheit (°F). The units will be used in displaying the process temperature, set-point, and proportional band.

The temperature scale units selection is accessed after the set-point adjustment function by pressing “SET”. From the temperature display function access the units selection by pressing “SET” 3 times.

 *Process temperature*

 *Access set-point memory*

 *Set-point memory*

 *Access set-point value*

 *Set-point value*

 *Access scale units selection*

 *Scale units currently selected*

Press “UP” or “DOWN” to change the units.

 *Change units*

 *New units selected*

Press “SET” to accept the new selection and access the scan.

 *Set the new units and access the scan*

7.4 Scan

The scan rate can be set and enabled so that when the set-point is changed the controller allows heating or cooling at a specified rate (degrees per minute) until it reaches the new set-point. With the scan disabled the controller allows heating or cooling at the maximum possible rate.

7.4.1 Scan Control

The scan is controlled with the scan on/off function that appears in the main menu after the temperature scale units.

 *Scan function off*

Press “UP” or “DOWN” to toggle the scan on or off.

 *Scan function on*

Press “SET” to accept the present setting and continue.

 *Accept scan setting*

7.4.2 Scan Rate

The next function in the main menu is the scan rate. The scan rate can be set from .1 to 99.9°C/min. The maximum scan rate however is actually limited by the natural heating or cooling rate of the instrument. This is often less than 100°C/min, especially when cooling.

The scan rate function appears in the main menu after the scan control function. The scan rate units are in degrees per minute, degrees C or F depending on the selected units.

 *Scan rate in°C/min*

Press “UP” or “DOWN” to change the scan rate.

 *New scan rate*

Press “SET” to accept the new scan rate and continue.

 *Accept scan rate*

7.5 Set-point Resistance

The set-point resistance is used for calibrating the instrument. See [Section 9](#). Pressing “SET” and “DOWN” simultaneously displays this value.

7.6 Secondary Menu

Functions which are used less often are accessed within the secondary menu. The secondary menu is accessed by pressing “SET” and “EXIT” simultaneously and then releasing. The first function in the secondary menu is the heater power display.

7.7 Heater Power

The temperature controller controls the temperature of the system by pulsing the heater on and off. The total power being applied to the heater is determined by the duty cycle or the ratio of heater on time to the pulse cycle time. By knowing the amount of heating the user can tell if the system is heating up to the set-point, cooling down, or controlling at a constant temperature. Monitoring the percent heater power lets the user know how stable the temperature is. With good control stability the percent heating power should not fluctuate more than $\pm 1\%$ within one minute.

The heater power display is accessed in the secondary menu. Press “SET” and “EXIT” simultaneously and release. The heater power will be displayed.

 *Access heater power in secondary menu*

100.0 P Heater power

To exit out of the secondary menu press “EXIT”. To continue on to the proportional band setting function press “SET”.

EXIT Return to temperature display

7.8 Proportional Band

In a proportional controller such as this the heater output power is proportional to the process temperature over a limited range of temperatures around the set-point. This range of temperature is called the proportional band. At the bottom of the proportional band the heater output is 100%. At the top of the proportional band the heater output is 0. Thus as the temperature rises the heater power is reduced, which consequently tends to lower the temperature back down. In this way the temperature is maintained at a fairly constant value.

The temperature stability of the system depends on the width of the proportional band. See Figure 6. If the band is too wide the temperature will tend to deviate excessively from the set-point due to varying external conditions. This is because the power output changes very little with temperature and the controller cannot respond very well to changing conditions or noise in the system. If the proportional band is too narrow the temperature may swing back and forth because the controller overreacts to temperature variations. For best control stability the proportional band must be set for the optimum width.

The optimum proportional band width depends on several factors including

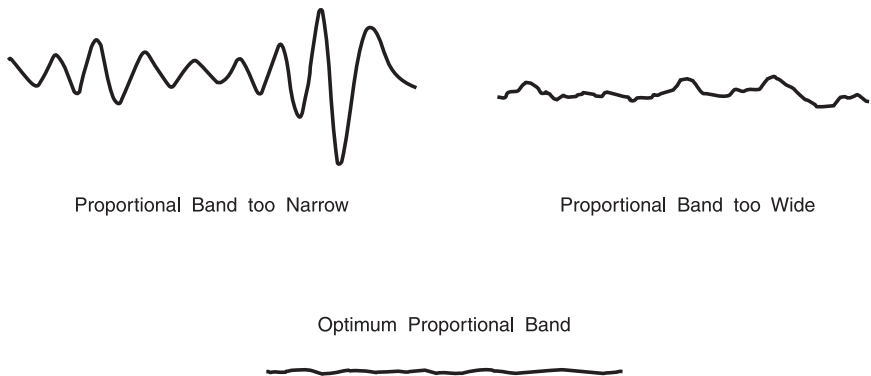

Figure 6 Various Proportional Band Settings

system heat transfer characteristics and heater-probe positioning. Thus the proportional band width may require adjustment for best stability when any of these conditions change.

The proportional band width is easily adjusted from the controller front panel. The width may be set to discrete values in degrees C or F depending on the selected units. The optimum proportional band width setting may be determined by monitoring the stability with a high resolution thermometer or with the controller percent output power display. Narrow the proportional band width to the point at which the process temperature begins to oscillate and then increase the band width from this point to 3 or 4 times wider.

The proportional band adjustment may be accessed within the secondary menu. Press “SET” and “EXIT” to enter the secondary menu and show the heater power. Then press “SET” to access the proportional band.

 +  *Access heater power in secondary menu*

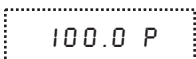
 *Heater power*

 *Access proportional band*

 *Flashes “P r o P” and then*

 *displays proportional band setting*

To change the proportional band press “UP” or “DOWN”.

 *Decrement display*

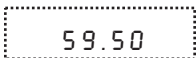
 *New proportional band setting*

To accept the new setting and access configuration menu press “SET”. Pressing “EXIT” will exit the secondary menu ignoring any changes just made to the proportional band value.

 *Accept the new proportional band setting*

7.9 Controller Configuration

The controller has a number of configuration and operating options and calibration parameters which are programmable via the front panel. These are accessed from the secondary menu after the proportional band by pressing “SET”. The display will prompt with “C O N F I G”. Press “SET” once more. There are 3 sets of configuration parameters — calibration parameters, operating parameters, and serial interface parameters. The menus are selected using the “UP” and “DOWN” keys and then pressing “SET”. See [Figure 5](#).

7.10 Calibration Parameters



CAUTION: Care should be exercised when adjusting these parameters as they affect the accuracy of the set-point. This procedure is explained in detail in Section 9.

The calibration parameter menu is indicated by,



Calibration parameters menu

Press “SET” five times to enter the menu. The calibration parameters menu contains the parameters, R_0 , ALPHA, DELTA, BETA, and the integral time adjustment which characterize the resistance-temperature relationship of the platinum control probe.

These parameters may be adjusted by an experienced user to improve the accuracy of the controller.

The calibration parameters are accessed by pressing “SET” after the name of the parameter is displayed. The value of the parameter may be changed using the “UP” and “DOWN” buttons. After the desired value is reached press “SET” to set the parameter to the new value. Pressing “EXIT” will cause the parameter to be skipped ignoring any changes that may have been made.

7.10.1 **R0**

This calibration parameter refers to the resistance of the control probe at 0°C. The value of this parameter is set at the factory for best instrument accuracy.

7.10.2 **ALPHA**

This calibration parameter refers to the average sensitivity of the probe between 0 and 100°C. The value of this parameter is set at the factory for best instrument accuracy.

7.10.3 **DELTA**

This calibration parameter relates to the second order nonlinearity of the sensor. The value of this parameter is set at the factory for best instrument accuracy.

7.10.4 **BETA**

This calibration parameter relates to the higher order nonlinearity of the sensor below 0°C. The value of this parameter is set at the factory for best instrument accuracy.

7.10.5 Integral time adjustment

The integral time should be adjusted for the quickest settling time without causing instability. As a general rule, the optimum integral time is about 80% of the period of the natural oscillation of the system.

7.11 Operating Parameters

The operator of the controller has access to setup constants. The correct values are important for the safety of the system.

The operating parameters menu is indicated by,

 *Operating parameters menu*

Press “SET” to enter the menu.

7.11.1 HL and LL

These parameters set the high and low set-point limits of the system. These parameters should not be set beyond the safe operating temperature limits of the system.

From the “P A R” menu press “SET”.

 *High level set-point*

Press “SET” to adjust the high level set-point or press “EXIT” to access the low level set-point.

 *Access high level set-point value*

 *Adjust the high level set-point*

 *Decrement the high level set-point*

 *New high level set-point*

When the desired high level set-point value is reached, press “SET” to accept the new value and access the low level set-point.



 *Low level set-point*

Press “SET” to adjust the low level set-point or press “EXIT” to access the decimal place setting.



Access low level set-point value

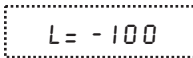

Adjust the low level se-point



Increment the low level set-point

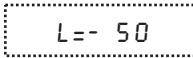

New low level set-point

When the desired low level set-point value is reached, press “SET” to accept the new value and access the decimal place setting.



7.11.2 DP (Decimal Place)

DP allows the user to set the decimal place on the display for one or two decimal places. DP defaults to two places.

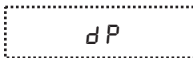

Decimal place setting

Press “SET” and then “UP” or “DOWN” to change the decimal place setting or press “EXIT” to return to the beginning of the “PAR” menu.



Access decimal place setting

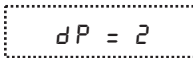

Adjust decimal place setting



Decrement the decimal place setting

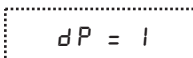

New decimal place setting

Press “SET” to accept the new decimal place setting.



7.12 Serial Interface Parameters

The serial RS-232 interface parameters menu is indicated by,



Serial RS-232 interface parameters menu

The serial interface parameters menu contains parameters which determine the operation of the serial interface. These controls only apply to controllers fitted with the serial interface. The parameters in the menu are — BAUD rate, sample period, duplex mode, and linefeed.

7.12.1 Baud Rate

The baud rate is the first parameter in the menu. The baud rate setting determines the serial communications transmission rate.

The baud rate parameter is indicated by,

`BAUD` *Serial baud rate parameter*

Press “SET” to choose to set the baud rate. The current baud rate value is then displayed.

`2400 b` *Current baud rate*

The baud rate of the serial communications may be programmed to 300, 600, 1200, 2400, 4800, or 9600 baud. Use “UP” or “DOWN” to change the baud rate value.

`4800 b` *New baud rate*

Press “SET” to set the baud rate to the new value or “EXIT” to abort the operation and skip to the next parameter in the menu.

7.12.2 Sample Period

The sample period is the next parameter in the serial interface parameter menu. The sample period is the time period in seconds between temperature measurements transmitted from the serial interface. If the sample rate is set to 5, for instance, the controller transmits the current measurement over the serial interface approximately every five seconds. The automatic sampling is disabled with a sample period of 0. The sample period is indicated by,

`SPER` *Serial sample period parameter*

Press “SET” to choose to set the sample period. The current sample period value will be displayed.

`SP = 1` *Current sample period (seconds)*

Adjust the value with “UP” or “DOWN” and then use “SET” to set the sample rate to the displayed value.

`SP = 50` *New sample period*

7.12.3 Duplex Mode

The next parameter is the duplex mode. The duplex mode may be set to full duplex or half duplex. With full duplex any commands received by the controller

via the serial interface will be immediately echoed or transmitted back to the device of origin. With half duplex the commands will be executed but not echoed. The duplex mode parameter is indicated by,

`d U P L` *Serial duplex mode parameter*

Press “SET” to access the mode setting.

`d = F U L L` *Current duplex mode setting*

The mode may be changed using “UP” or “DOWN” and pressing “SET”.

`d = H A L F` *New duplex mode setting*

7.12.4 Linefeed

The final parameter in the serial interface menu is the linefeed mode. This parameter enables (on) or disables (off) transmission of a linefeed character (LF, ASCII 10) after transmission of any carriage-return. The linefeed parameter is indicated by,

`LF` *Serial linefeed parameter*

Press “SET” to access the linefeed parameter.

`LF = O N` *Current linefeed setting*

The mode may be changed using “UP” or “DOWN” and pressing “SET”.

`LF = O F F` *New linefeed setting*

8 Digital Communication Interface

The 2200 controller is capable of communicating with and being controlled by other equipment through the digital interface. The RS-232 serial interface is standard.

Hart recommends the use of shielded RS-232 cables for all remote communication.

8.1 Serial Communications

The controller comes installed with an RS-232 serial interface that allows serial digital communications over fairly long distances. With the serial interface the user may access any of the functions, parameters and settings discussed in Section 7 with the exception of the BAUD rate setting. The serial interface operates with 8 data bits, 1 stop bit, and no parity.

8.1.1 Wiring

The serial communications cable attaches to the controller through the DB-9 connector on the back panel.

Figure 7 shows the pin-out of this connector and suggested cable wiring. To eliminate noise, the serial cable should be shielded with low resistance between the connector (DB-9) and the shield.

8.1.2 Setup

Before operation, the serial interface must first be set up by programming the BAUD rate and other configuration parameters. These parameters are programmed within the serial interface menu.

To enter the serial parameter programming mode first press "EXIT" while pressing "SET" and release to enter the secondary menu. Press "SET" repeatedly until the display reads "P r o b E".

RS-232 Cable Wiring for IBM PC and Compatibles

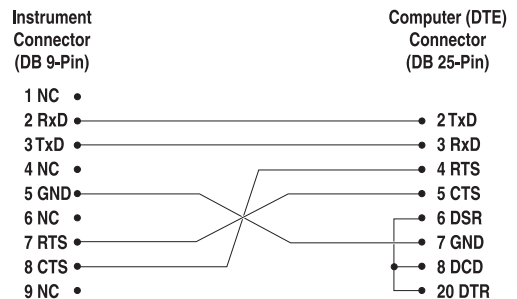
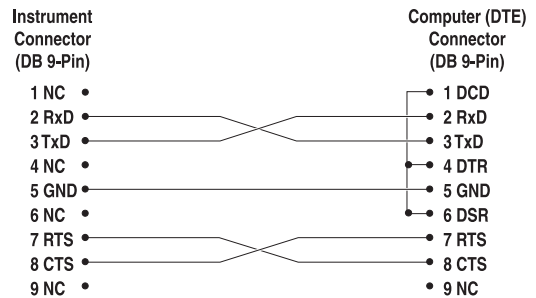

Figure 7 Serial Cable Wiring

Press “UP” repeatedly until the serial interface menu is indicated with “SERIAL”. Finally press “SET” to enter the serial interface parameters menu. In the serial interface parameters menu are the BAUD rate, sample rate, duplex mode, and linefeed parameters.

8.1.2.1 Baud Rate

The baud rate is the first parameter in the menu. The display prompts with the baud rate parameter by showing “BAUD”. Press “SET” to choose to set the baud rate. The current baud rate value is displayed. The baud rate of the serial communications may be programmed to 300, 600, 1200, 2400, 4800, or 9600 baud. The baud rate is pre-programmed to 2400 baud. Use “UP” or “DOWN” to change the baud rate value. Press “SET” to set the baud rate to the new value or “EXIT” to abort the operation and skip to the next parameter in the menu.

8.1.2.2 Sample Period

The sample period is the next parameter in the menu and prompted with “SPER”. The sample period is the time period in seconds between temperature measurements transmitted from the serial interface. If the sample rate is set to 5, for instance, the controller transmits the current measurement over the serial interface approximately every five seconds. The automatic sampling is disabled with a sample period of 0. Press “SET” to choose to set the sample period. Adjust the period with “UP” or “DOWN” and then use “SET” to set the sample rate to the displayed value.

8.1.2.3 Duplex Mode

The next parameter is the duplex mode indicated with “dUPL”. The duplex mode may be set to half duplex (“HALF”) or full duplex (“FULL”). With full duplex any commands received by the bath via the serial interface will be immediately echoed or transmitted back to the device of origin. With half duplex the commands will be executed but not echoed. The default setting is full duplex. The mode may be changed using “UP” or “DOWN” and pressing “SET”.

8.1.2.4 Linefeed

The final parameter in the serial interface menu is the linefeed mode. This parameter enables (“On”) or disables (“OFF”) transmission of a linefeed character (LF, ASCII 10) after transmission of any carriage-return. The default setting is with linefeed on. The mode may be changed using “UP” or “DOWN” and pressing “SET”.

8.1.3 Serial Operation

Once the cable has been attached and the interface set up properly the controller immediately begins transmitting temperature readings at the programmed rate. The serial interface operates with 8 data bits, 1 stop bit, and no parity. The set-point and other commands may be sent to the controller via the serial interface. The interface commands are discussed in [Section 8.2](#). All commands are

ASCII character strings terminated with a carriage-return character (CR, ASCII 13).

8.2 Interface Commands

The various commands for accessing the controller functions via the digital interface are listed in this section (see Table 2). All commands are terminated with a carriage-return character. The interface makes no distinction between upper and lower case letters, hence either may be used. Commands may be abbreviated to the minimum number of letters which determines a unique command. A command may be used to either set a parameter or display a parameter depending on whether or not a value is sent with the command following a “=” character. For example “s”<CR> will return the current set-point and “s=50.00”<CR> will set the set-point (set-point 1) to 50.00 degrees.

In the following list of commands, characters or data within brackets, “[” and “]”, are optional for the command. A slash, “/”, denotes alternate characters or data. Numeric data, denoted by “n”, may be entered in decimal or exponential notation. Characters are shown in lower case although upper case may be used. Spaces may be added within command strings and will simply be ignored. Backspace (BS, ASCII 8) may be used to erase the previous character. A terminating CR is implied with all commands.

Table 2 Interface Commands

Command Description	Command Format	Command Example	Returned	Returned Example	Acceptable Values
Display Temperature					
Read current set-point	s[etpoint]	s	set: 9999.99 {C or F}	set: 150.00 C	
Set current set-point to <i>n</i>	s[etpoint]= <i>n</i>	s=350			Instrument Range
Read temperature	t[emperature]	t	t: 9999.9 {C or F}	t: 55.6 C	
Read temperature units	u[nits]	u	u: x	u: c	
Set temperature units:	u[nits]=c/f				C or F
Set temperature units to Celsius	u[nits]=c	u=c			
Set temperature units to Fahrenheit	u[nits]=f	u=f			
Read scan mode	sc[an]	sc	sc: on		
Set scan mode	sc[an]=on/off	sc=on			ON or OFF
Read scan rate	sr[ate]	sr	srat: 99.9 {Cor F}/min	srat:10.0 C/min	
Set scan rate	sr[ate]= <i>n</i>	sr=1.1			.1 to 99.9
Secondary Menu					
Read proportional band setting	pr[opband]	pr	pb: 999.9	pb: 15.9	
Set proportional band to <i>n</i>	pr[opband]= <i>n</i>	pr=8.83			Depends on Configuration
Read heater power (duty cycle)	po[wer]	po	po: 999.9	po: 1.0	
Configuration Menu					
Cal Menu					
Read R0 calibration parameter	r[0]	r	r0: 999.999	r0: 100.578	
Set R0 calibration parameter to <i>n</i>	r[0]= <i>n</i>	r=100.324			98.0 to 104.9
Read ALPHA calibration parameter	al[pha]	al	al: 9.9999999	al: 0.0038573	
Set ALPHA calibration parameter to <i>n</i>	al[pha]= <i>n</i>	al=0.0038433			.002 to .006
Read DELTA calibration parameter	de[lta]	de	de: 9.999	de: 1.507	
Read DELTA calibration parameter	de[lta]= <i>n</i>	de=1.3742			0–3.0
Operating Parameters Menu					
Read high level set-point	hl	hl	hl:999	hl:800	
Set high level set-point	hl= <i>n</i>	hl=100			100 to 800
Read low level set-point	ll	ll	ll:999	ll: –100	
Set low level set-point	ll= <i>n</i>	ll= –50			–100 to 0
Read decimal place	dp	dp	dp: 9	dp: 1	

Interface Commands continued

Command Description	Command Format	Command Example	Returned	Returned Example	Acceptable Values
Set decimal place	dp=n	dp=1			1 or 2
Serial Interface Menu					
Read serial sample setting	sa[mple]	sa	sa: 9	sa: 1	
Set serial sampling setting to <i>n</i> seconds	sa[mple]=n	sa=0			0 to 999
Set serial duplex mode:	du[plex]=f[ull]/h[alf]				FULL or HALF
Set serial duplex mode to full	du[plex]=f[ull]	du=f			
Set serial duplex mode to half	du[plex]=h[alf]	du=h			
Set serial linefeed mode:	lf[eed]=on/of[f]				ON or OFF
Set serial linefeed mode to on	lf[eed]=on	lf=on			
Set serial linefeed mode to off	lf[eed]=of[f]	lf=of			
Calibration Menu					
Read firmware version number	*ver[sion]	*ver	ver.9999,9.99	ver.9141,1.21	
Read structure of all commands	h[elp]	h	list of commands		
Legend:	[] Optional Command data {} Returns either information n Numeric data supplied by user 9 Numeric data returned to user x Character data returned to user				
Note:	When DUPLEX is set to FULL and a command is sent to READ, the command is returned followed by a carriage return and linefeed. Then the value is returned as indicated in the RETURNED column.				

9 Calibration Procedure

9.1 Single Point Calibration

For a quick calibration to a single point, R_0 may be adjusted by itself without any calculations. If the system is reading high, adjust R_0 in the calibration menu higher by small increments until the temperature of the system is correct.



NOTE: This method may cause other temperature settings to be off by a degree or two.

9.2 Three Point Calibration Procedure

In some instances the user may want to calibrate the controller to improve the temperature set-point accuracy. Calibration is done by adjusting the controller probe calibration constants R_0 and ALPHA so that the process temperature, as measured with a standard thermometer, agrees more closely with the set-point. The thermometer used must be able to measure the temperature with higher accuracy than the desired accuracy of the system.

1. Choose three set-points to use in the calibration of the R_0 , ALPHA, and DELTA parameters.
2. Set the controller to the low set-point. When the calibrator reaches the set-point and is stable, wait 15 minutes or so and then take a reading from the thermometer. Sample the set-point resistance by holding down the SET key and pressing the DOWN key. Write these values down as T_1 and R_1 respectively.
3. Repeat step 2 for the other two set-points recording them as T_2 , R_2 , T_3 , and R_3 respectively.
4. Using the recorded data, calculate new values for R_0 , ALPHA, and DELTA parameters using the equations given below:

9.2.1 Compute DELTA:

$$A = T_3 - T_2$$

$$B = T_2 - T_1$$

$$C = \left[\frac{T_3}{100} \right] \left[1 - \frac{T_3}{100} \right] - \left[\frac{T_2}{100} \right] \left[1 - \frac{T_2}{100} \right]$$

$$D = \left[\frac{T_2}{100} \right] \left[1 - \frac{T_2}{100} \right] - \left[\frac{T_1}{100} \right] \left[1 - \frac{T_1}{100} \right]$$

$$E = R_3 - R_2$$

$$F = R_2 - R_1$$

$$delta = \frac{AF - BE}{DE - CF}$$

T₁₋₃ - Measured temperature using thermometer.

R₁₋₃ - Value of R from display of 2200 (Press SET and DOWN at the same time.)

where

T₁ and **R₁** are the measured temperature and resistance at 50.0 °C

T₂ and **R₂** are the measured temperature and resistance at 250.0 °C

T₃ and **R₃** are the measured temperature and resistance at 450.0 °C

9.2.2 Compute R₀ & ALPHA:

$$a_1 = T_1 + delta \left[\frac{T_1}{100} \right] \left[1 - \frac{T_1}{100} \right]$$

$$a_3 = T_3 + delta \left[\frac{T_3}{100} \right] \left[1 - \frac{T_3}{100} \right]$$

$$rzero = \frac{R_3 a_1 - R_1 a_3}{a_1 - a_3}$$

$$alpha = \frac{R_1 - R_3}{R_3 a_1 - R_1 a_3}$$

delta is the new value of DELTA computed above

5. Program the new values for DELTA (delta), R₀ (rzero) and ALPHA (alpha) into the calibrator with the following steps.

1. Press SET and EXIT keys at the same time and then press SET until **R₀** is displayed.
2. Press SET then use the UP or DOWN keys until the correct numerical setting is displayed. Press SET to accept the new value.
3. Repeat step 2 for ALPHA and DELTA.

9.2.3 Accuracy & Repeatability

1. Check the accuracy of the calibrator at various points over the calibrated range.
2. If calibrator does not pass specification at all set-points, repeat the **Calibration Procedure**.

10 Troubleshooting

This section contains information on troubleshooting and CE Comments

10.1 Troubleshooting Problems, Possible Causes, and Solutions

In the event that the instrument appears to function abnormally, this section may help to find and solve the problem. Several possible problem conditions are described along with likely causes and solutions. If a problem arises, please read this section carefully and attempt to understand and solve the problem. If the problem cannot otherwise be solved, contact an Authorized Service Center for assistance (see Section 1.4). Be sure to have the model number and serial number of your instrument available.

Problem	Possible Causes and Solutions
Incorrect temperature reading	<p>Incorrect R0 parameter. Find the value for R0 on the Report of Test that was shipped with the instrument (or from subsequent calibrations of the instrument). Reprogram the parameter into the controller (see Section 7.10.1, R0). Allow the instrument to stabilize and verify the accuracy of the temperature reading.</p> <p>Controller locked up. The controller may have locked up due to a power surge or other aberration. Initialize the system by performing the Factory Reset Sequence.</p> <p>Factory Reset Sequence. Hold the SET and EXIT buttons down at the same time while powering on the instrument. After the instrument displays <code>-101E-</code>, release the buttons. The display shows <code>-101E-</code>, then displays <code>2200</code>, and then displays the firmware version. After performing the master reset sequence, all of the configuration parameters are reset to their default values. Reprogram the R0 parameter into the controller (see Section 7.10.1, R0) and any other applicable configuration parameters. Allow the instrument to stabilize and verify the accuracy of the temperature reading.</p>
Blank display after mains power applied	<p>Blown fuse. A fuse may have blown due to a power surge or failure of a component. Replace the fuse once. If the fuse blows a second time, it is likely caused by the failure of a component. Always replace the fuse with one of the same rating, voltage, and type. Never replace the fuse with one of a higher current rating.</p>
The Instrument heats or cools too quickly or too slowly	<p>Incorrect scan and scan rate settings. The scan and scan rate settings may be set to unwanted values. Check the Scan and Scan Rate settings. The scan may be off (if the unit seems to be responding too quickly). The scan may be on with the Scan Rate set low (if unit seems to be responding too slowly).</p>

Problem	Possible Causes and Solutions
The display shows any of the following: <i>Err 1</i> , <i>Err 2</i> , <i>Err 3</i> , <i>Err 4</i> , or <i>Err 5</i>	Controller problem. The error messages signify the following problems with the controller. <i>Err 1</i> - a RAM error <i>Err 2</i> - a NVRAM error <i>Err 3</i> - a Structure error <i>Err 4</i> - an ADC setup error <i>Err 5</i> - an ADC ready error Initialize the system by performing the Factory Reset Sequence describe above.
The display shows <i>Err 6</i>	Defective control sensor. The control sensor may be shorted, open or otherwise damaged. Disconnect the control sensor from the instrument. Measure the resistance of the control sensor. The resistance between pins 2 and 3 should be 1-2 ohms. The resistance between pins 1 and 4 should be 1-2 ohms. The resistance between pins 1 or 4 and 2 or 3 should be approximately 110 ohms at room temperature (25 °C). If it measures close to this, re-connect the sensor, and reapply power to the instrument. If the error message returns, there is a problem with the controller.

10.2 CE Comments

10.2.1 EMC Directive

Hart Scientific's equipment has been tested to meet the European Electromagnetic Compatibility Directive (EMC Directive, 89/336/EEC). Selection of Light Industrial or Heavy Industrial compliance has been based on the intended use of the instrument. Units designed for use in a calibration laboratory have been tested to Light Industrial Standards. Units designed to be used in the "field" have been tested to both Light Industrial and Heavy Industrial Standards. The Declaration of Conformity for your instrument lists the specific standards to which the unit was tested.

10.2.2 Low Voltage Directive (Safety)

In order to comply with the European Low Voltage Directive (73/23/EEC), Hart Scientific equipment has been designed to meet the IEC 1010-1 (EN 61010-1) and IEC 1010-2-010 (EN 61010-2-010) standards.